

CHIBIHAMMER

40,000

TERMINATORS



Template by Ivan Albuja

Credits:

Many parts of these models were made with the original templates made by Eli Patoroch, Jim Bowen and

разработчик: **Ирина**

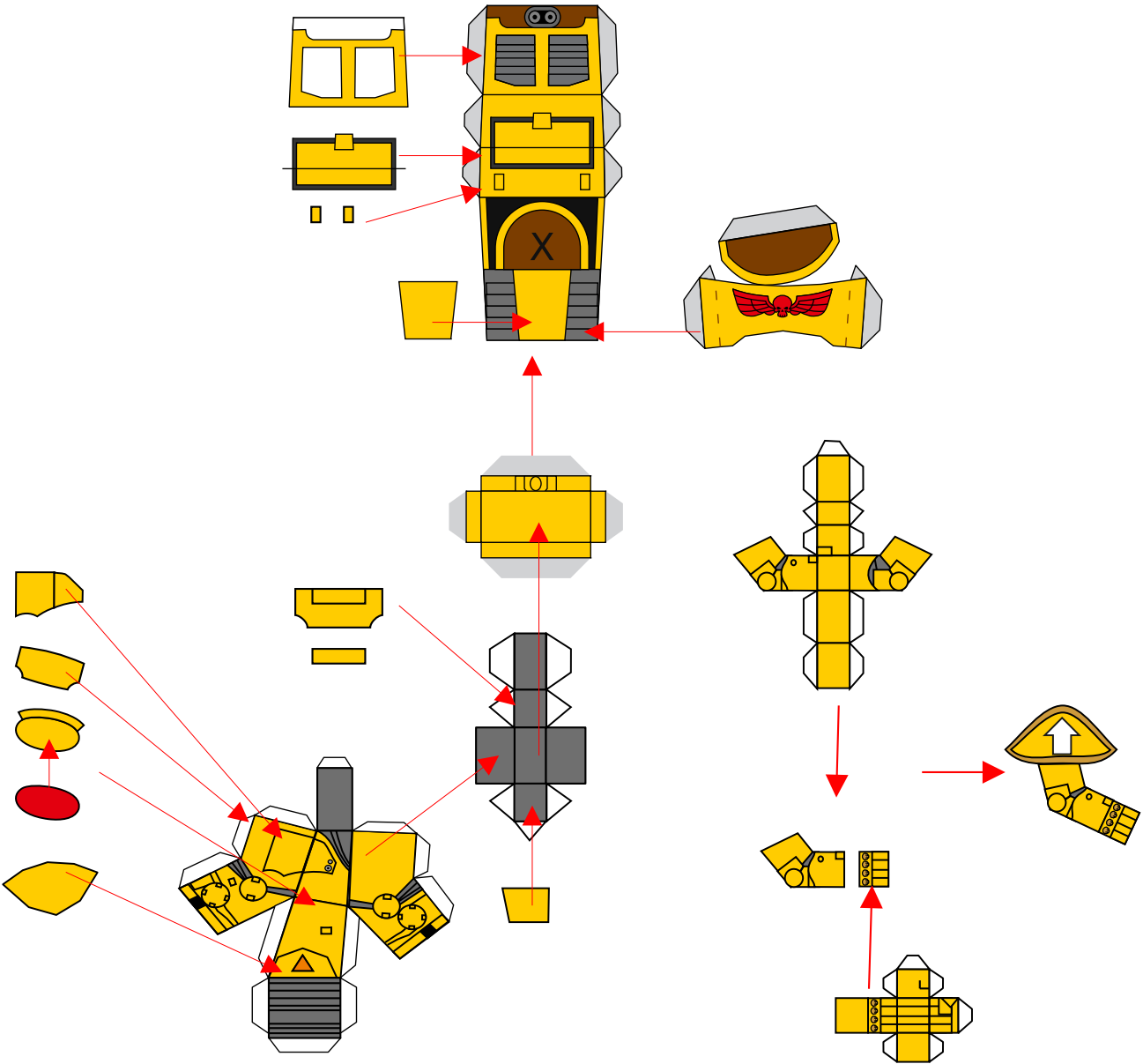
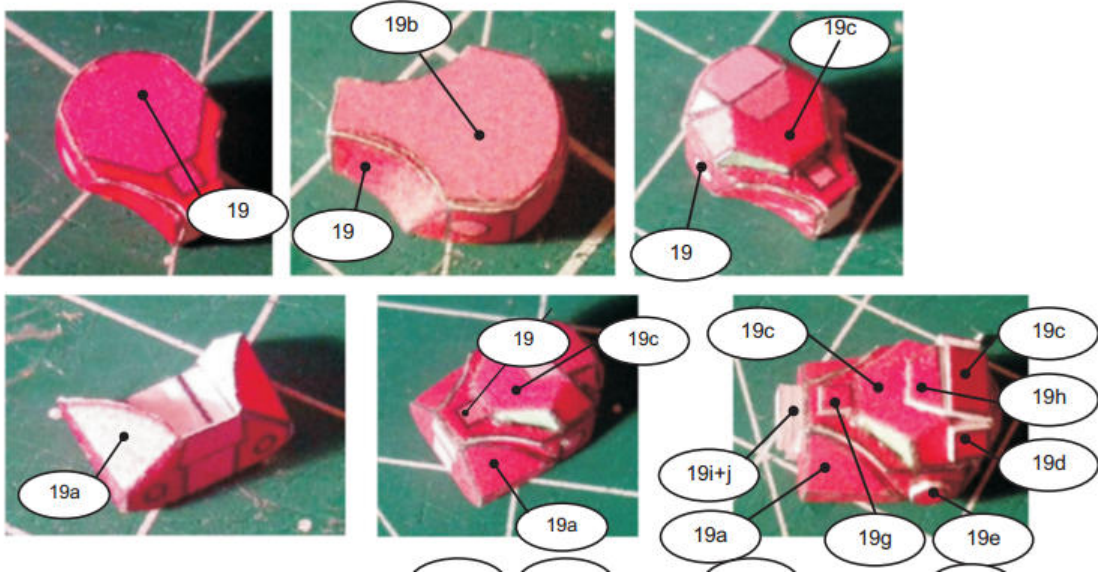

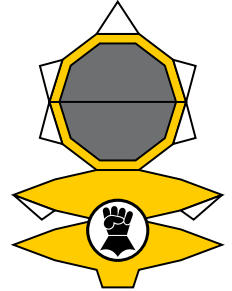
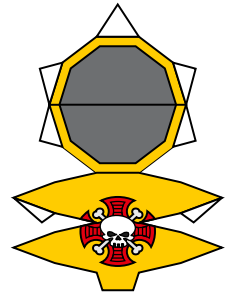
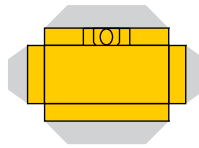
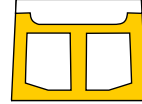
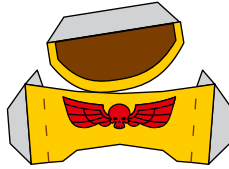
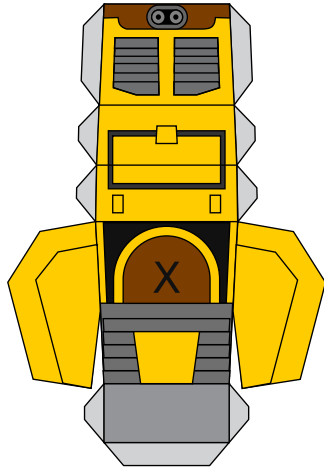
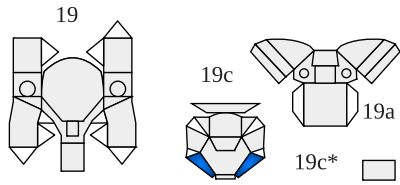

* Use this arms with bolters or gatling guns only

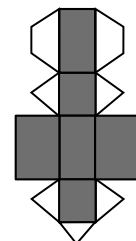
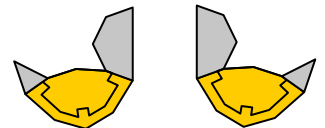
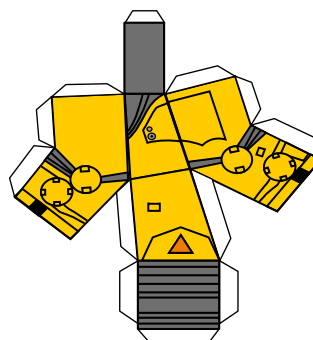
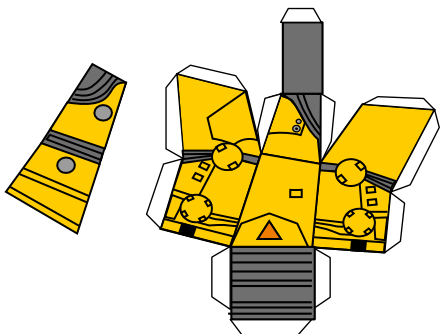
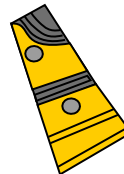
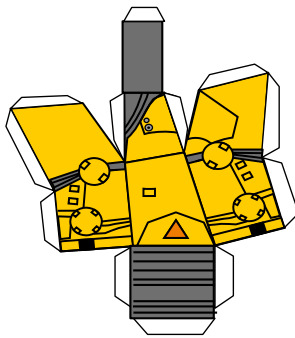
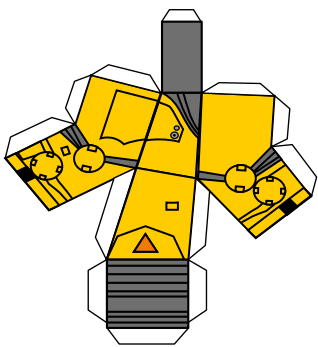
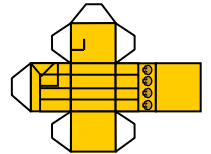
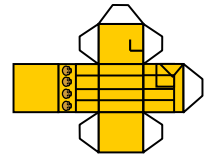
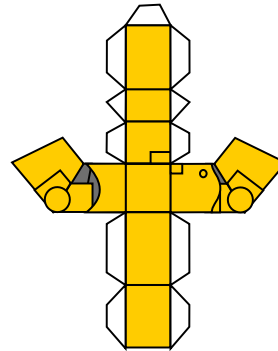
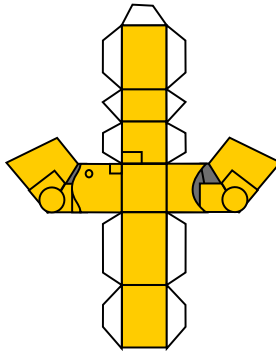
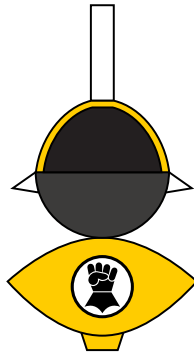
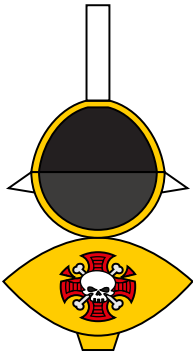

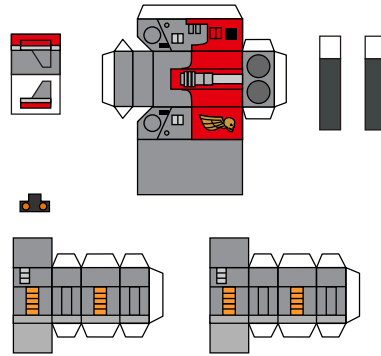
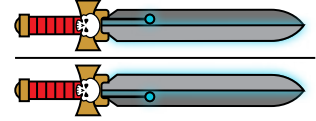
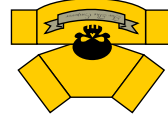
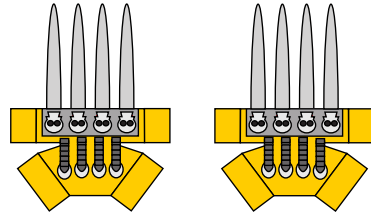
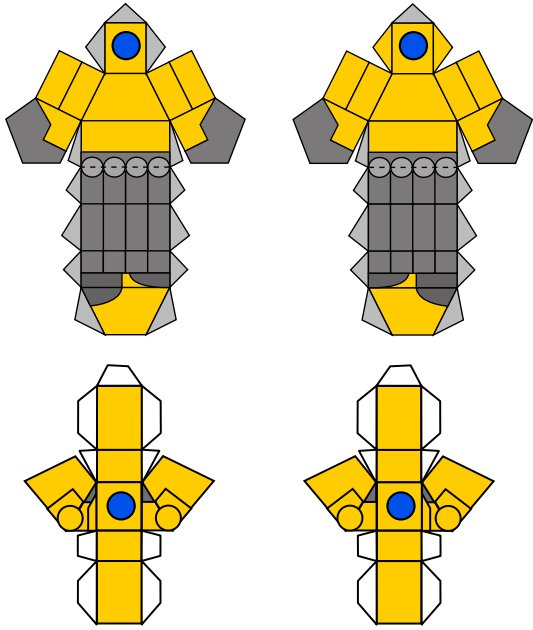

* Use this arms with power fist and claws

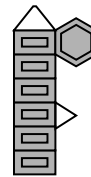
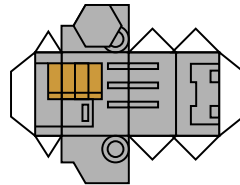
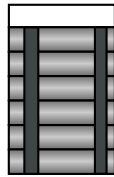
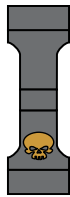
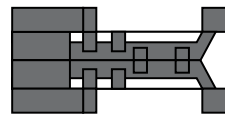
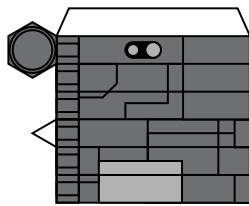
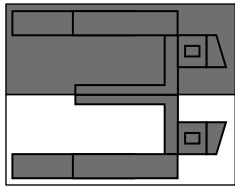

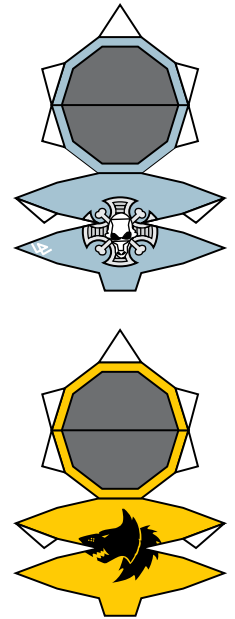
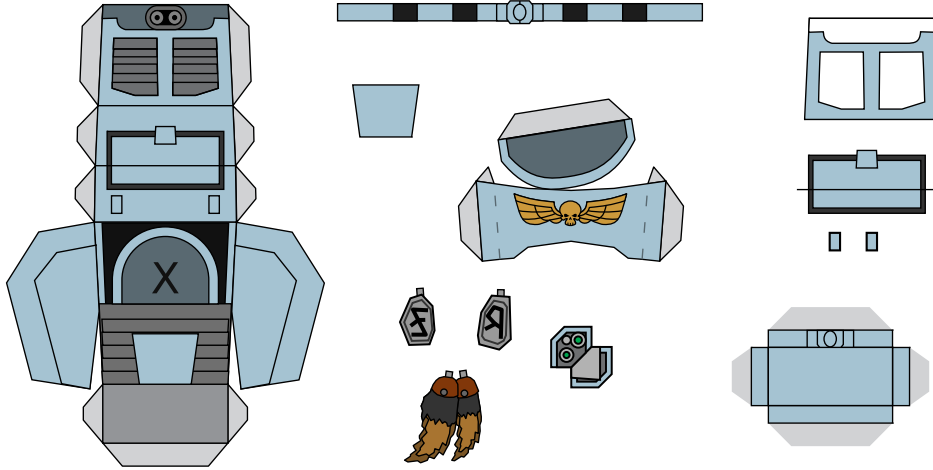
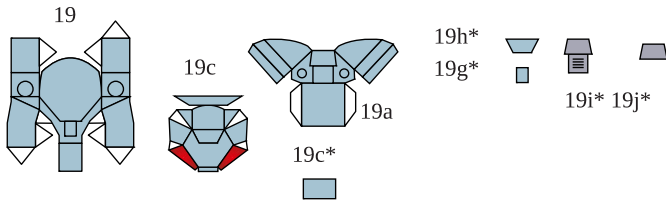

* Use this arms with bolters or gatling guns only

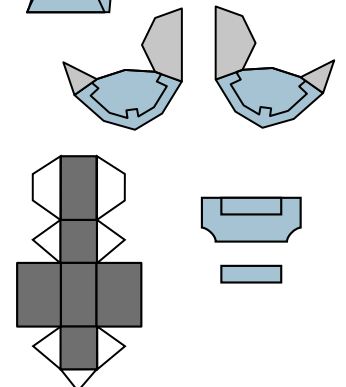
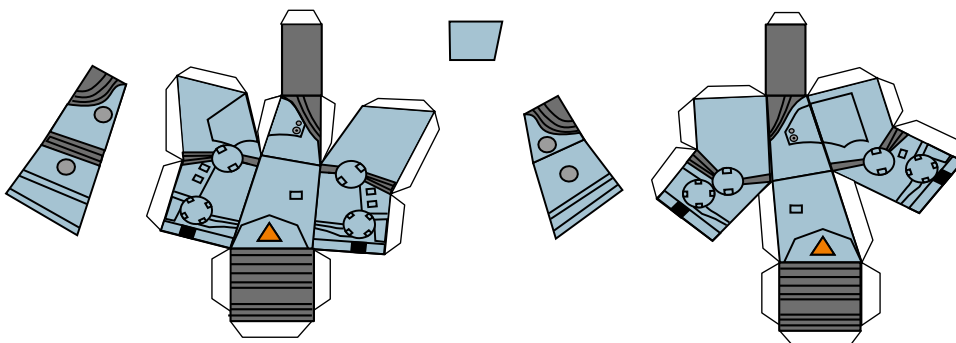
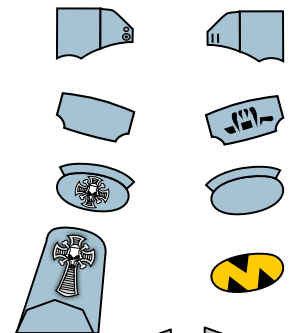
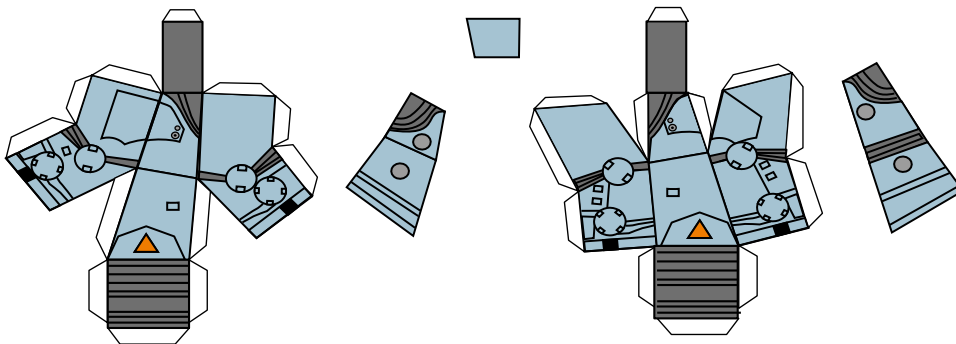
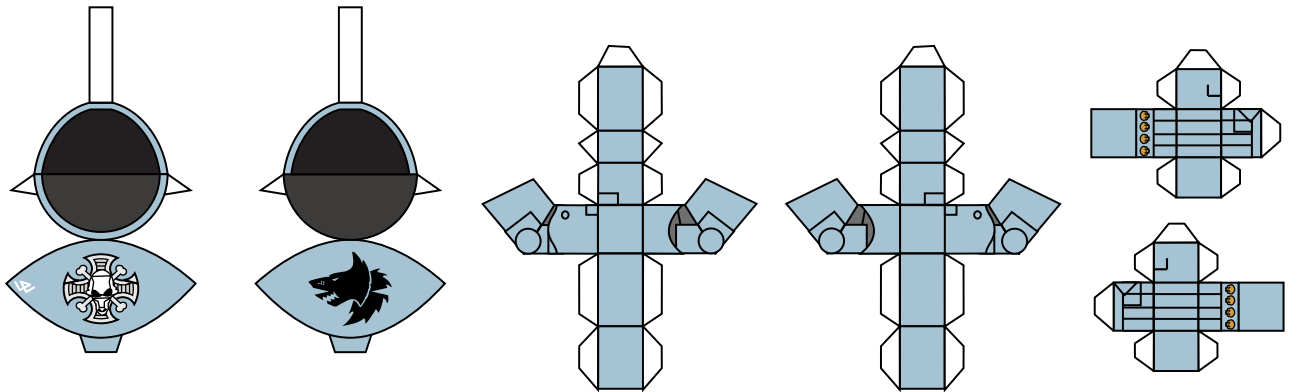

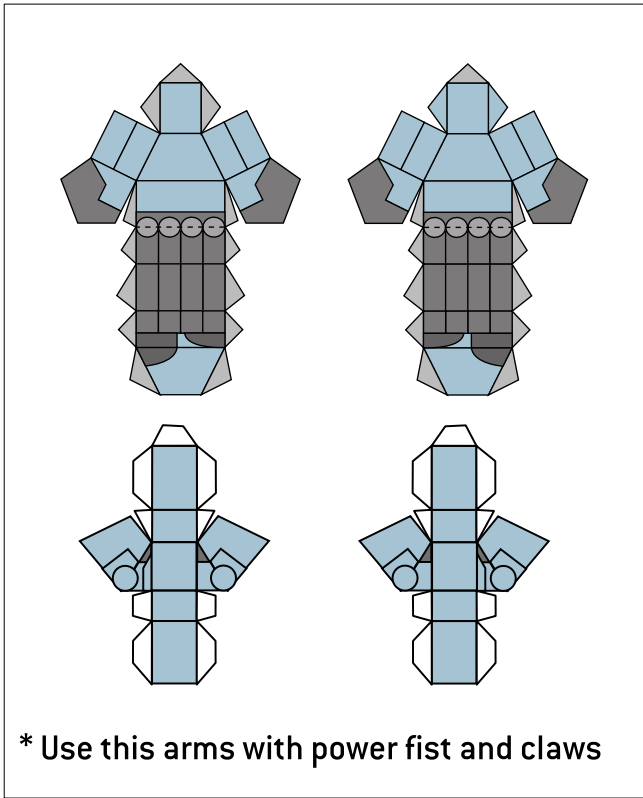

* Use this arms with power fist and claws

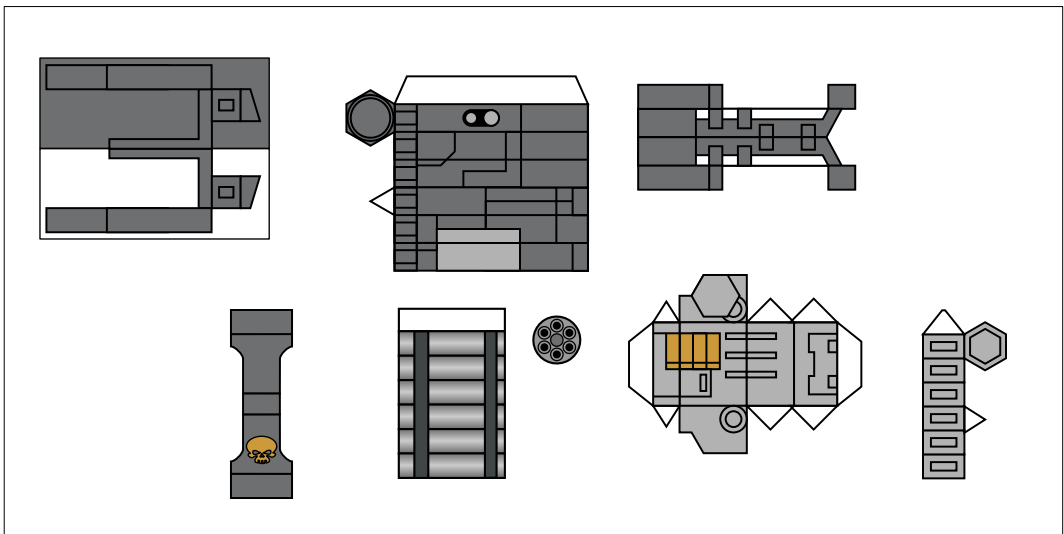
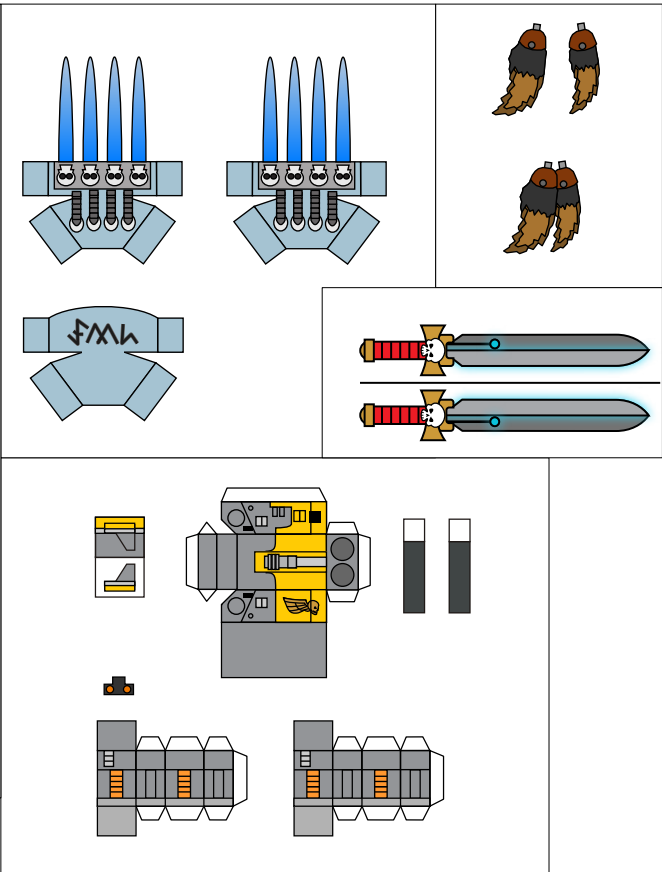

19

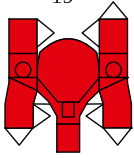

19c

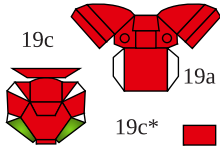

19a

19h*



19g*



19i* 19j*

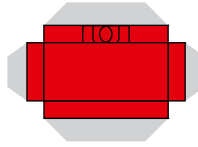
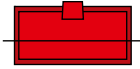
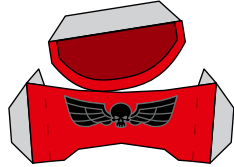
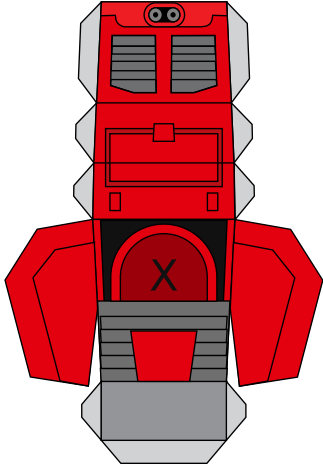
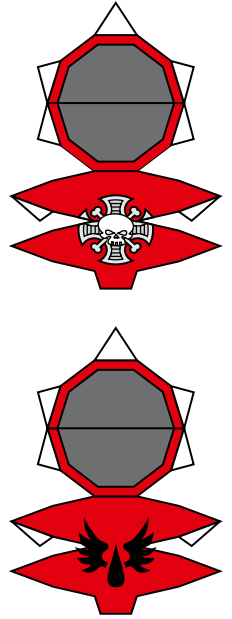

* Use this arms with bolters or gatling guns only

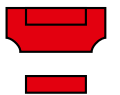
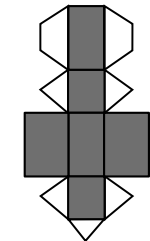
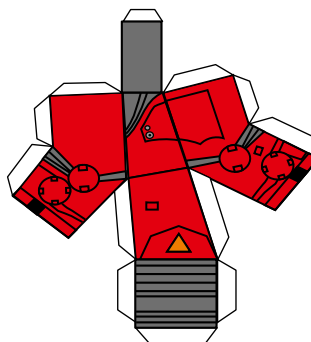
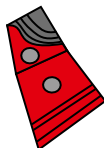
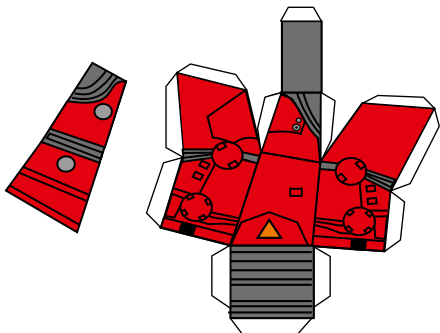
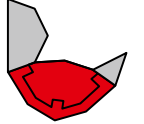
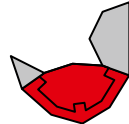
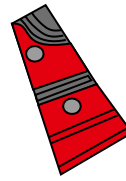
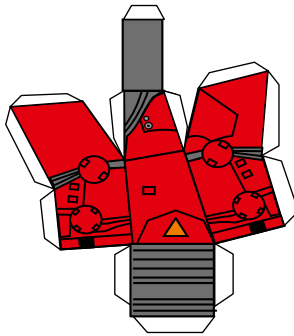
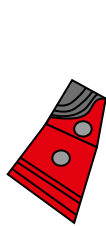
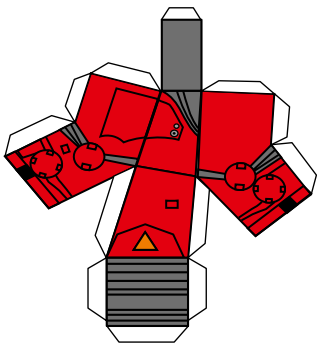
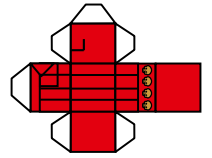
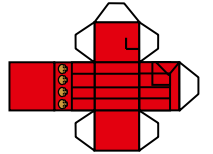
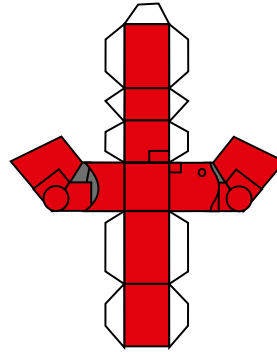
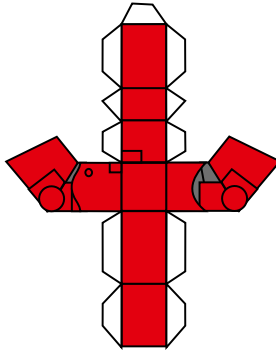
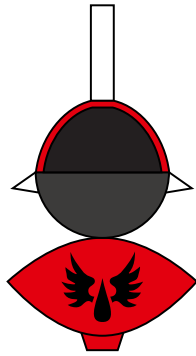
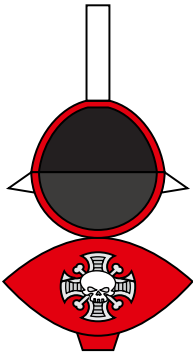

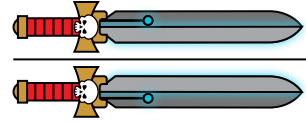
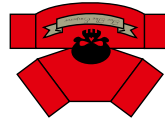
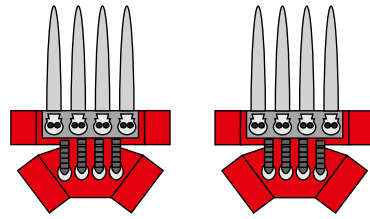
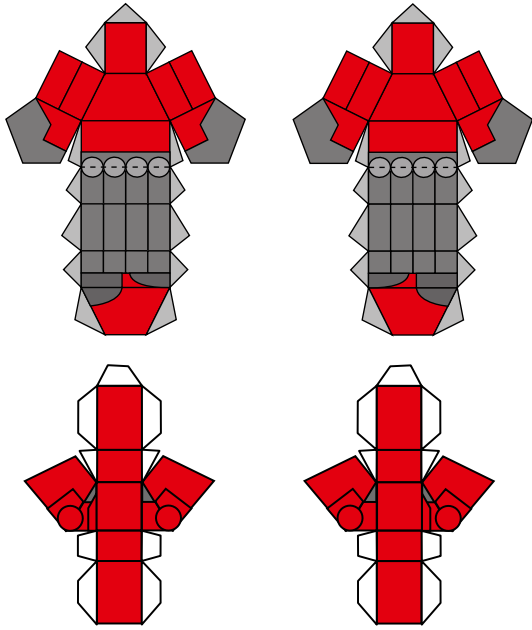

* Use this arms with power fist and claws

