

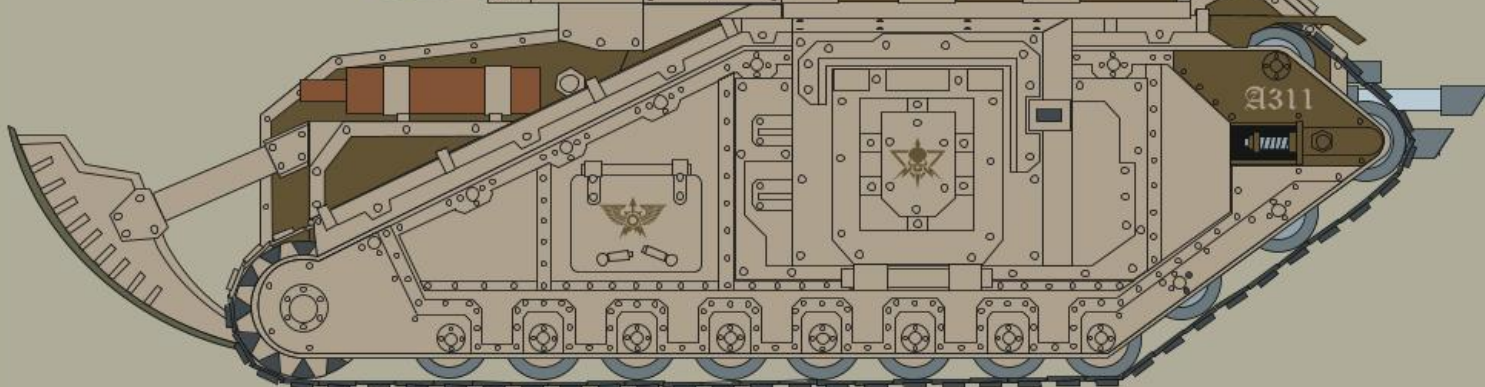

CHAPTER SOLAR AUXILIA BARBARAN AMBAXTOI

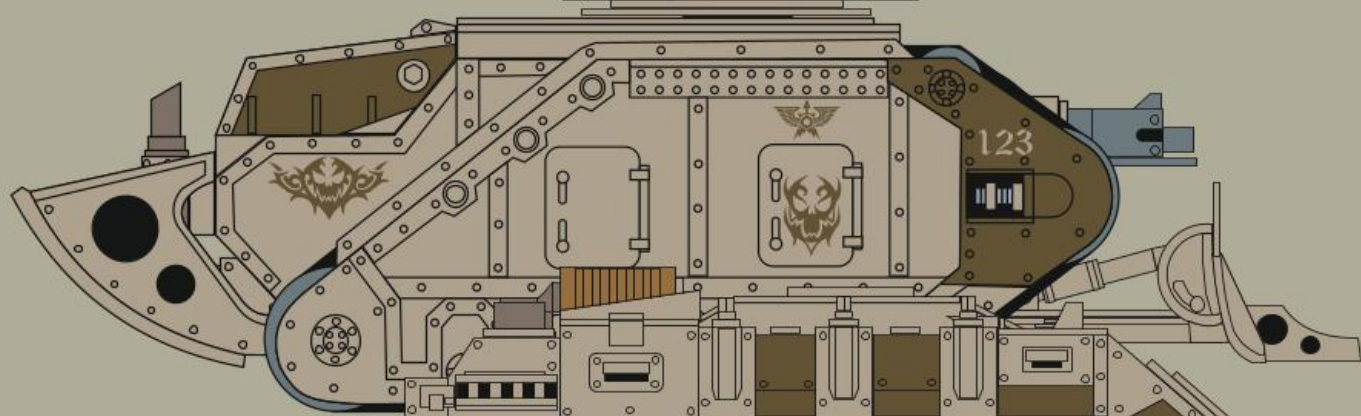

PATOROCH

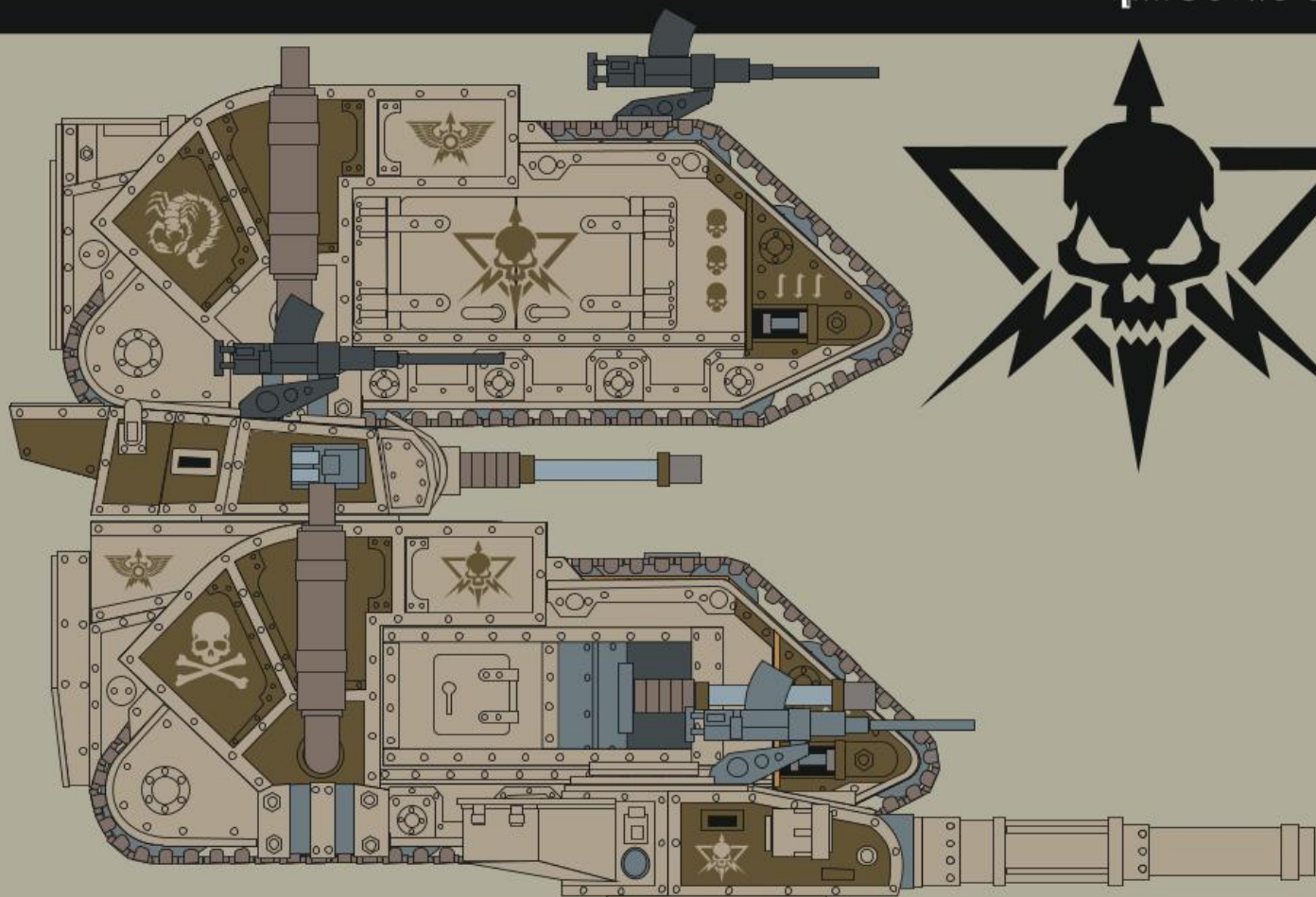

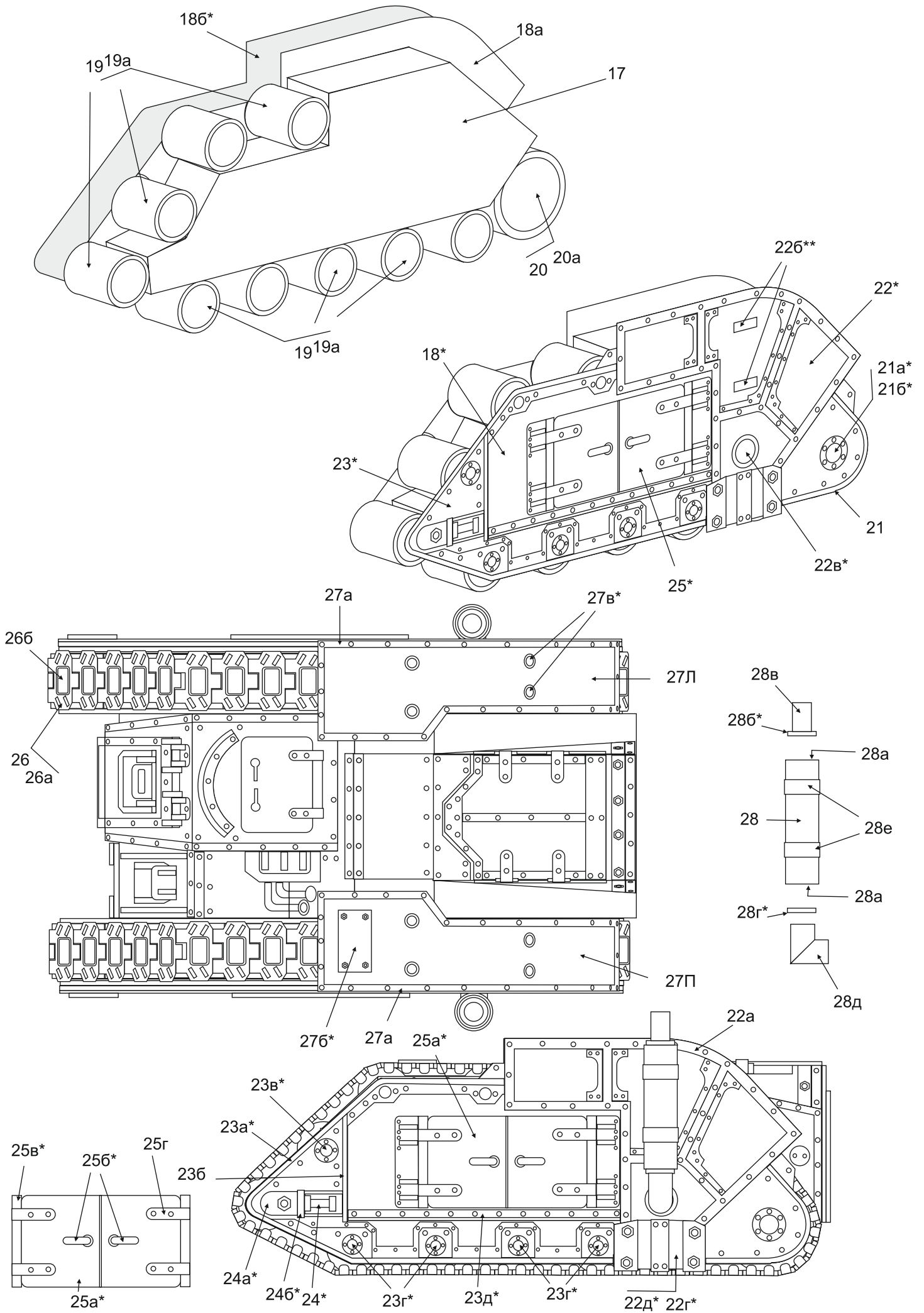

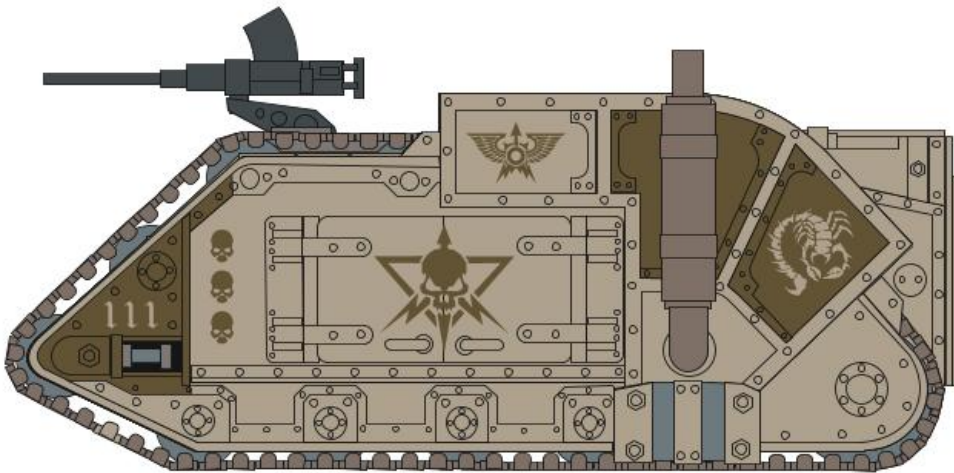
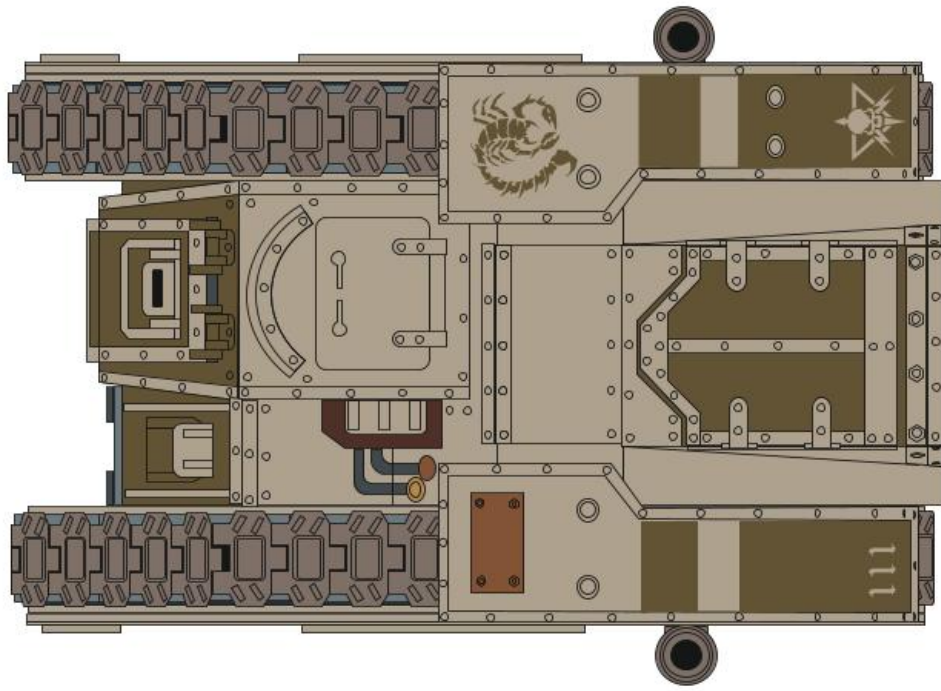

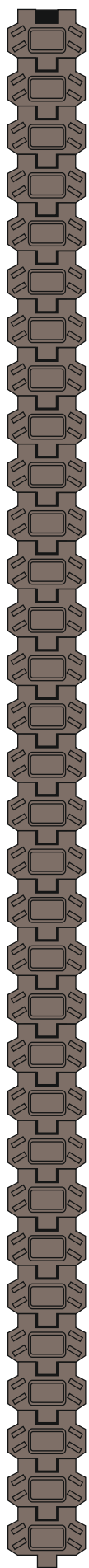

26

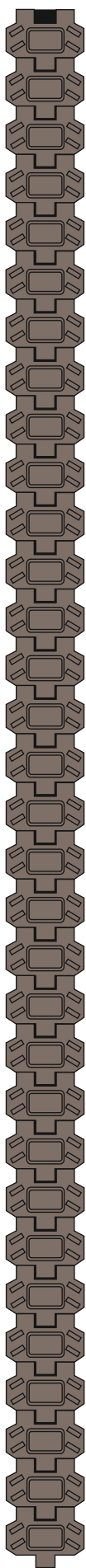

26a



26a

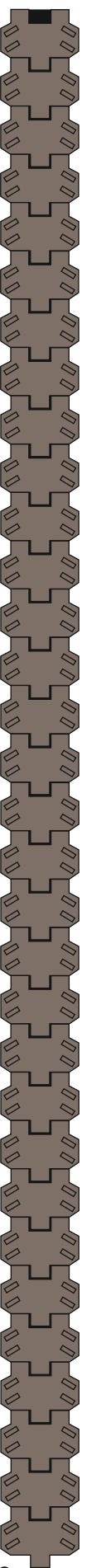

26a



26b

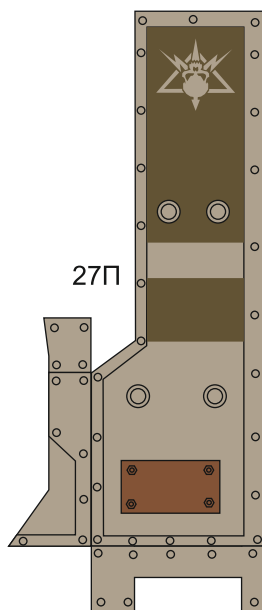

27П

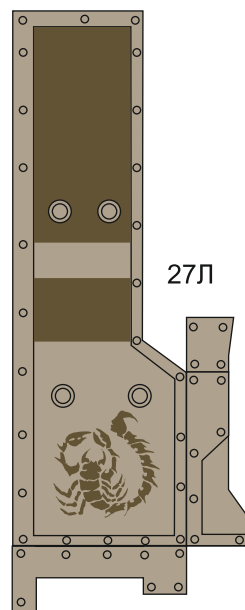

27Л

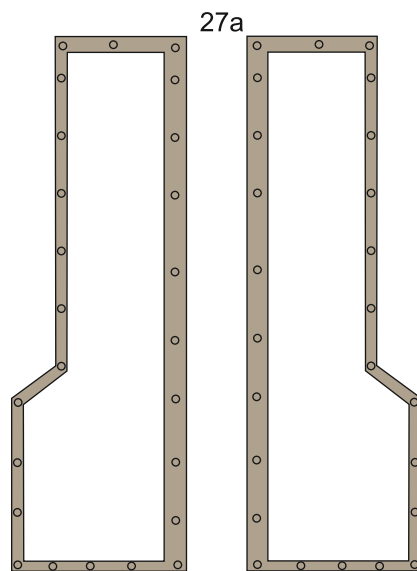

27a

27б*



27в*

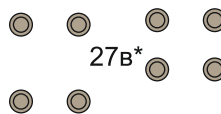

27г

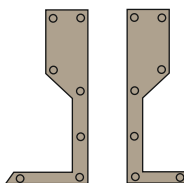

27д

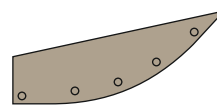
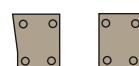

27e

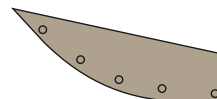

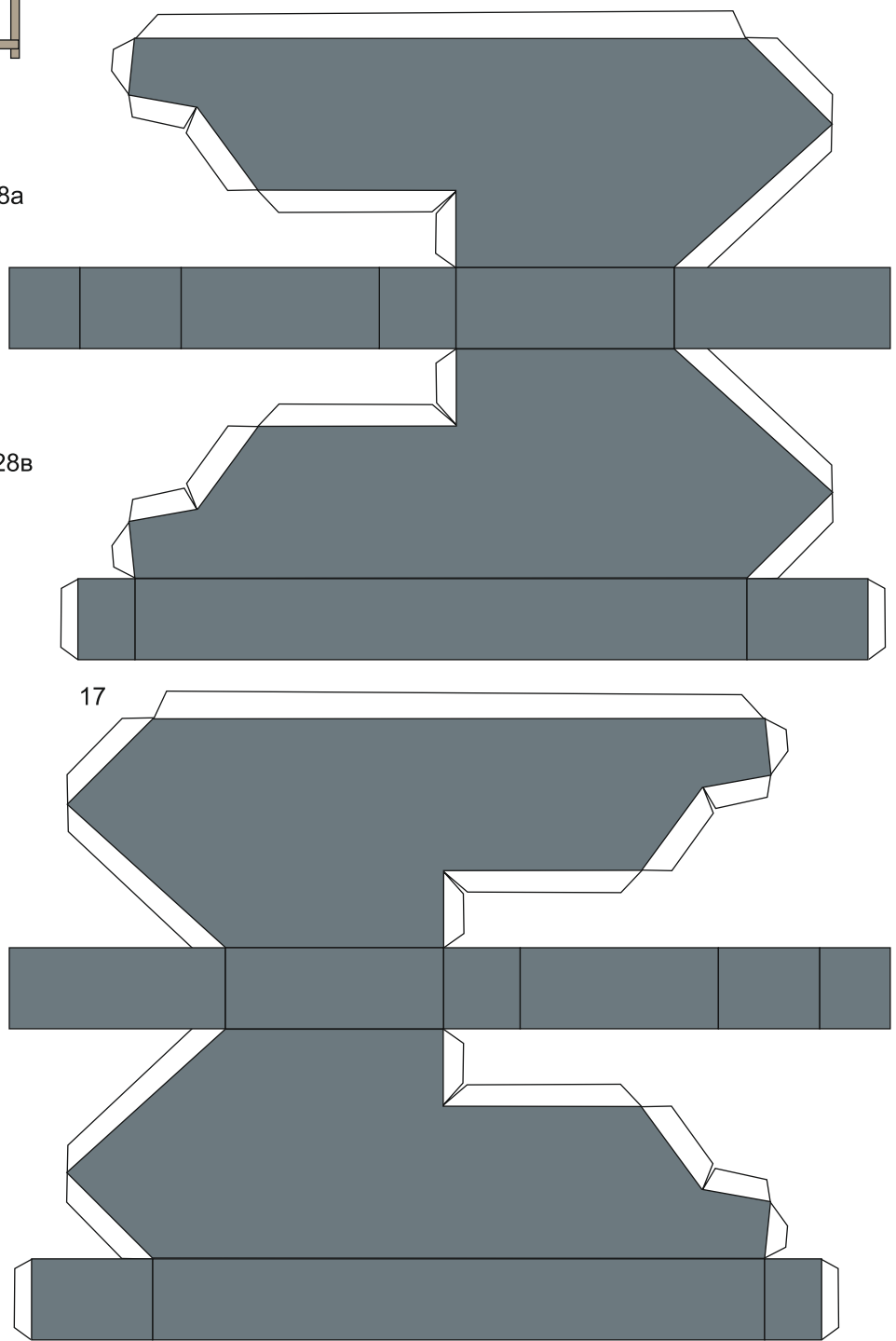
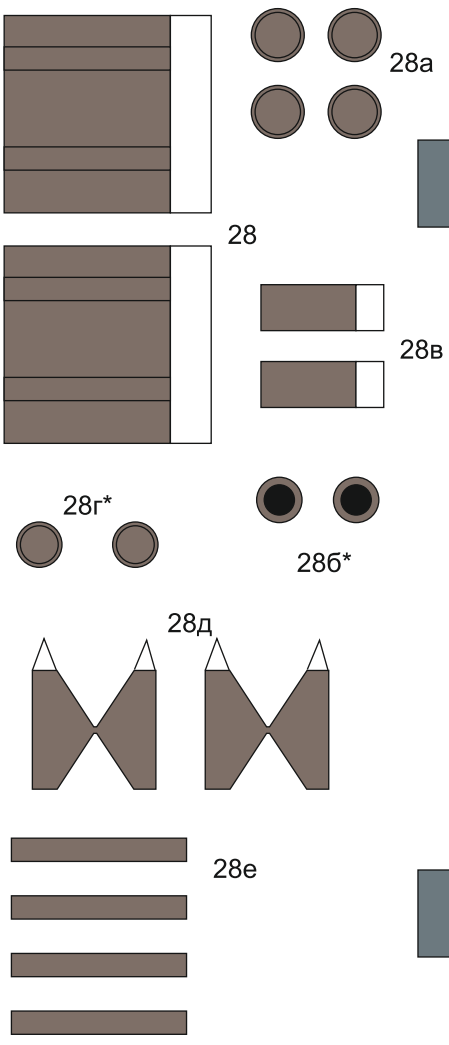
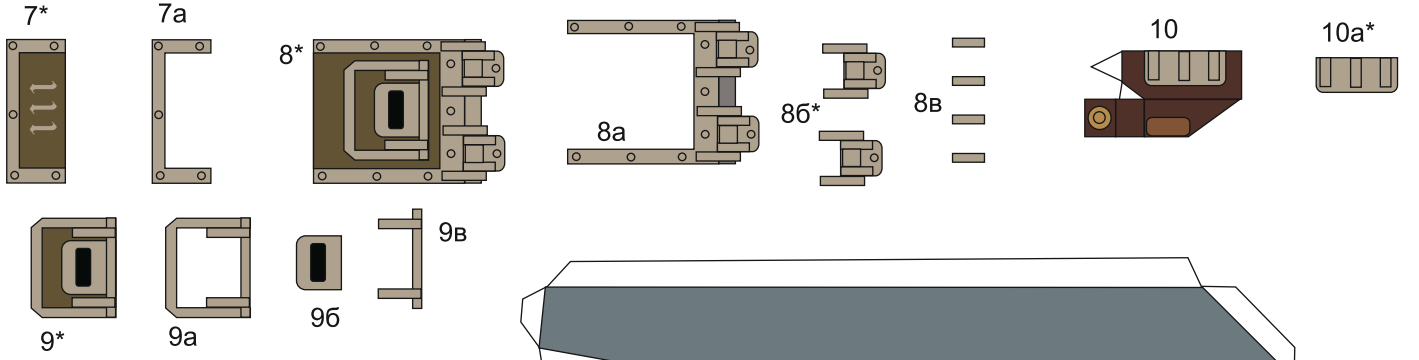
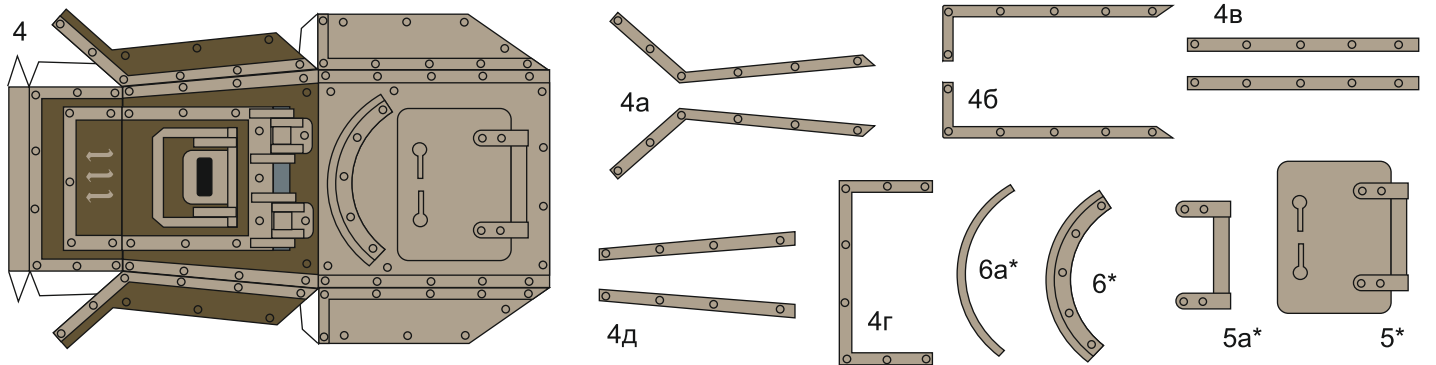

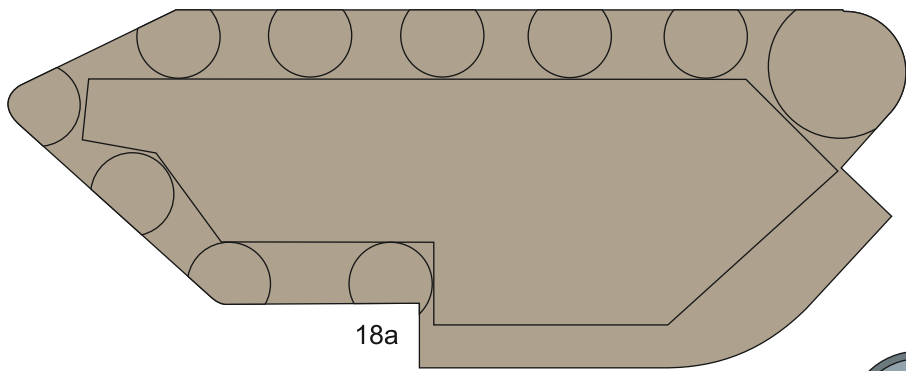

18a

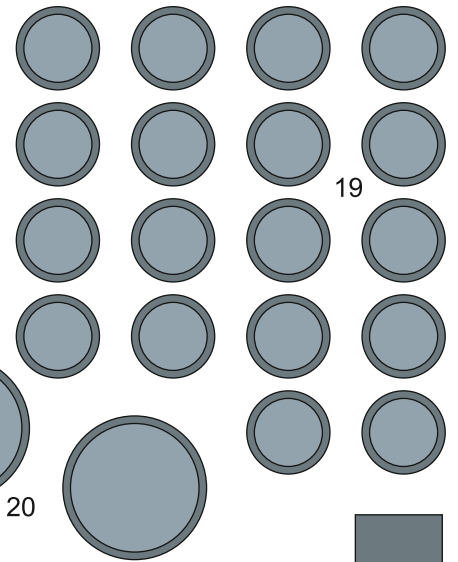

19

20

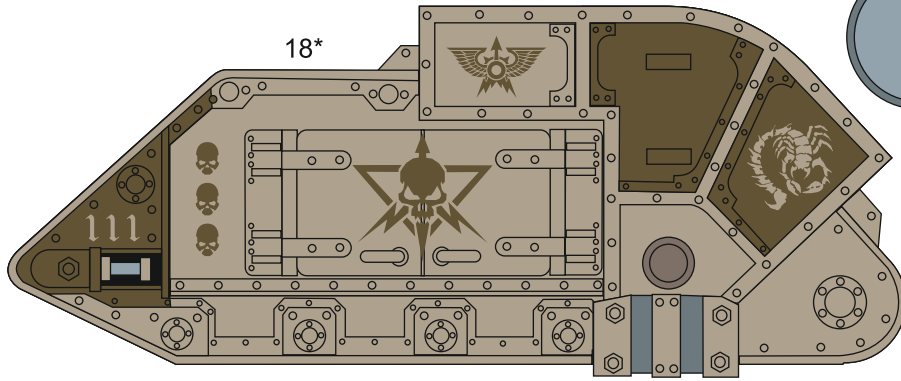

18*

19a

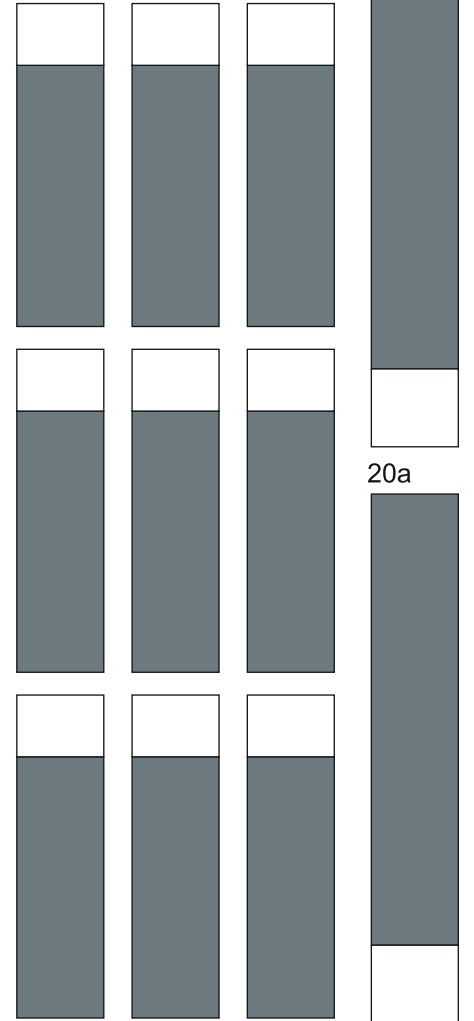

19a

20a

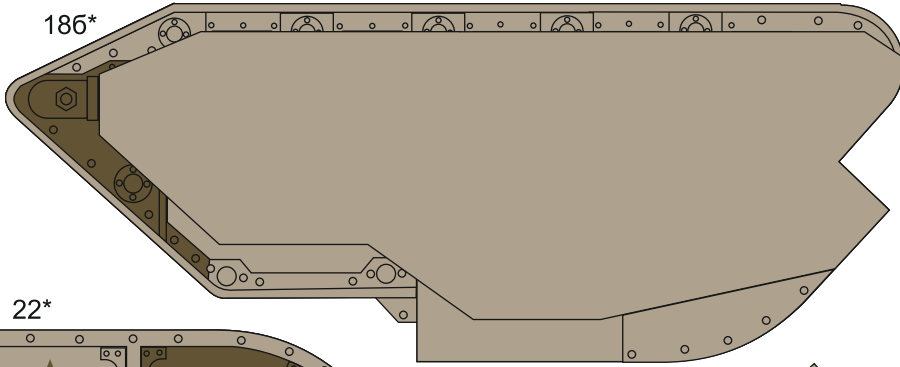

186*

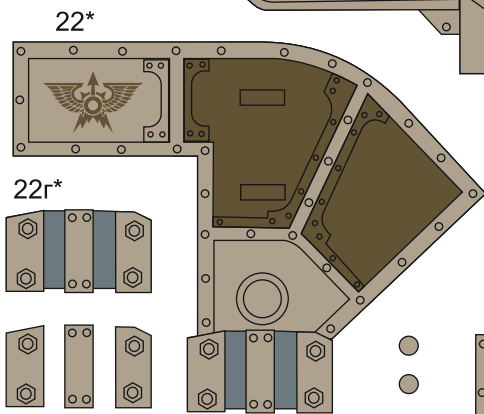

22*

22г*

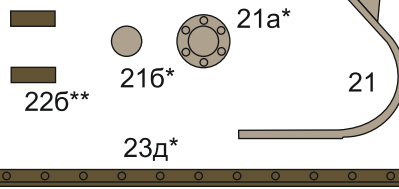

21a*

21б*

226**

21

23д*

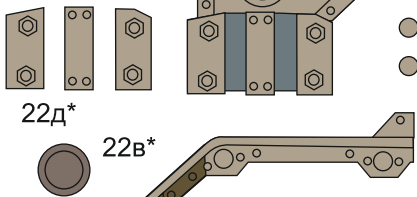

22д*

22в*

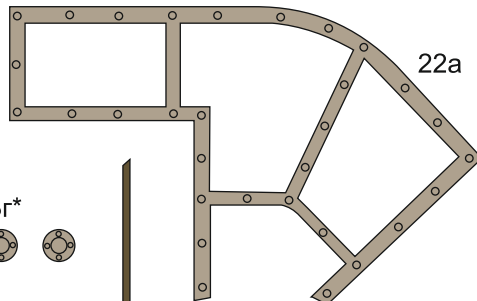

22a

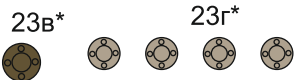

23в*

23г*



236

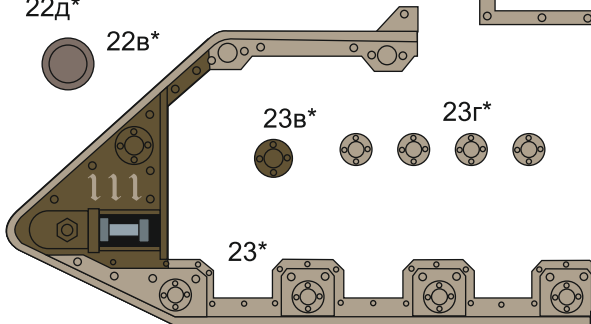

23*

23а*



25*

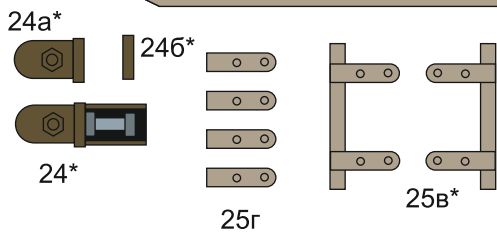

24а*

24б*

24*

25г

25в*

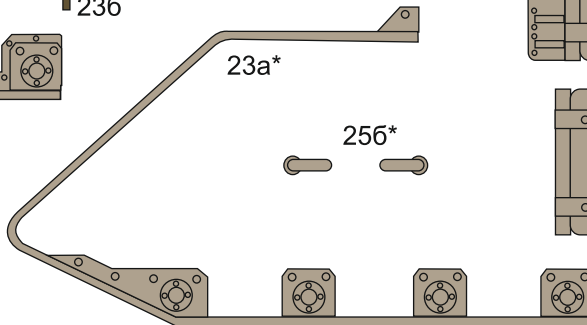

25б*



25а*

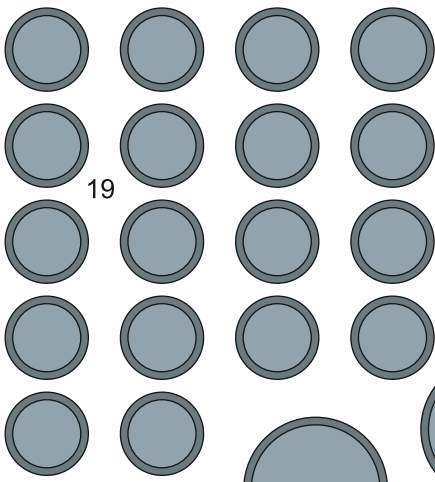

19

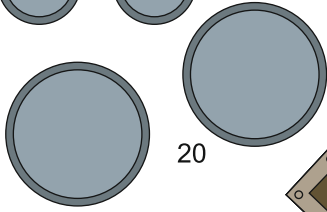

20



19a

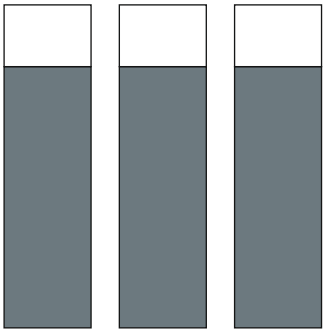

20a

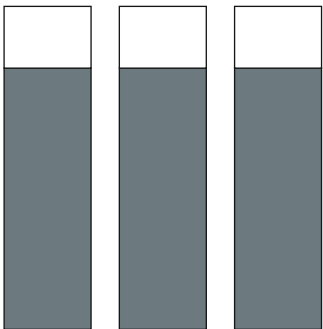
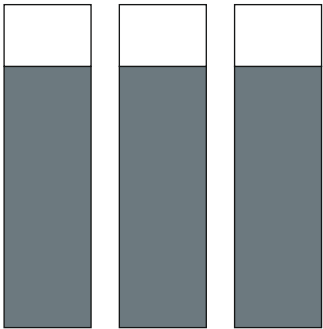

25*



25a*

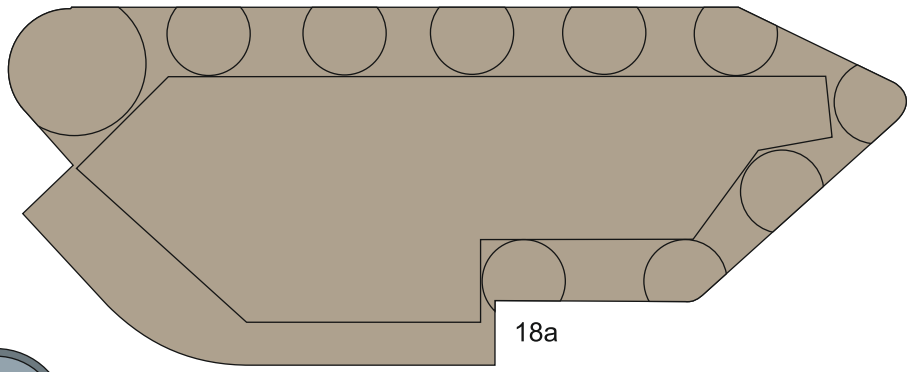

18a

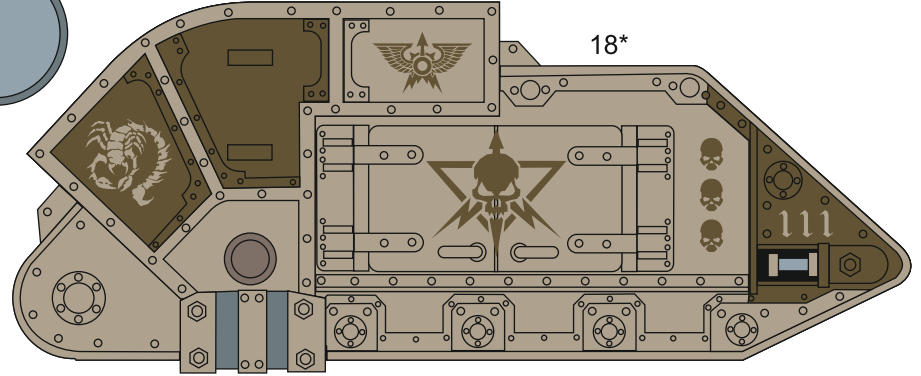

18*

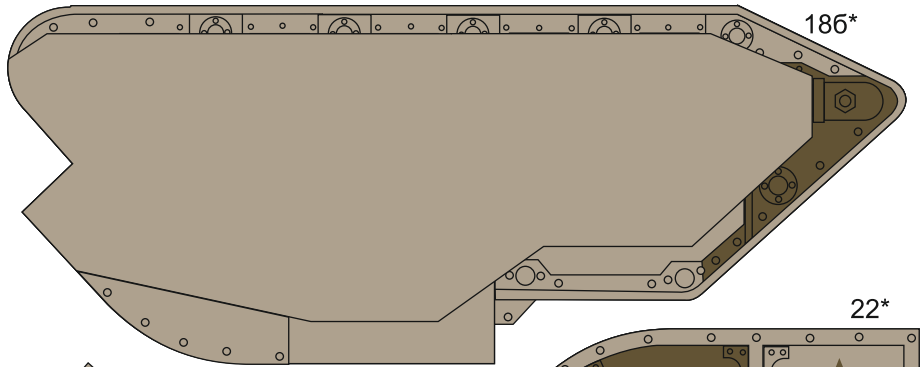

18b*

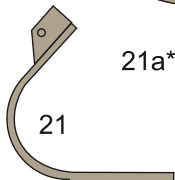

21

21a*



216*

226**

226**

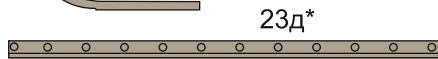

23d*

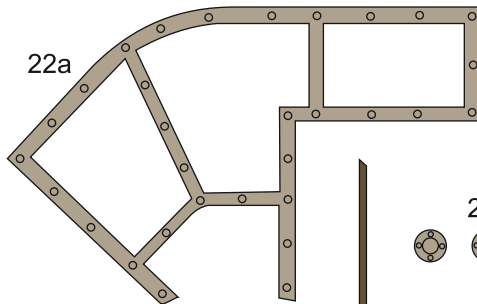

22a

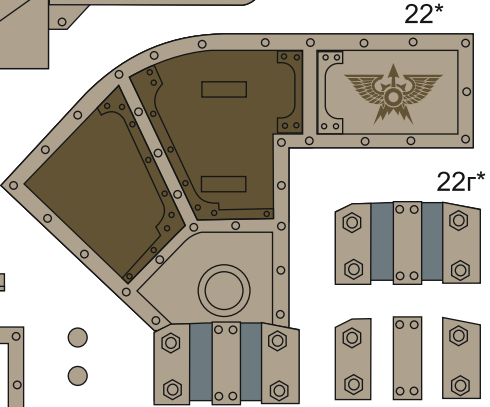

22*

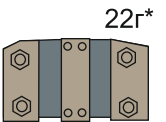

22г*

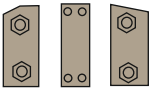

22д*

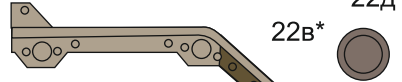

22в*

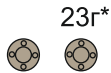

23г*



23в*

236

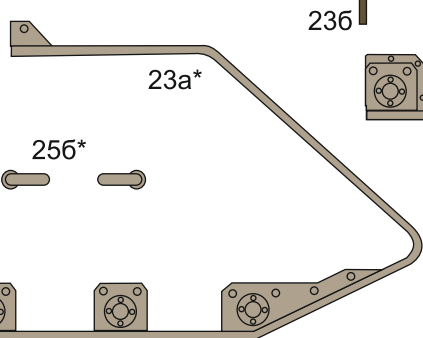

23a*

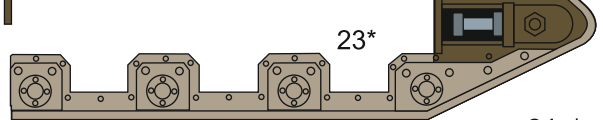

23*



256*

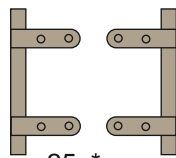

25b*

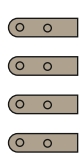

25г

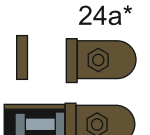

24a*



24*

246*

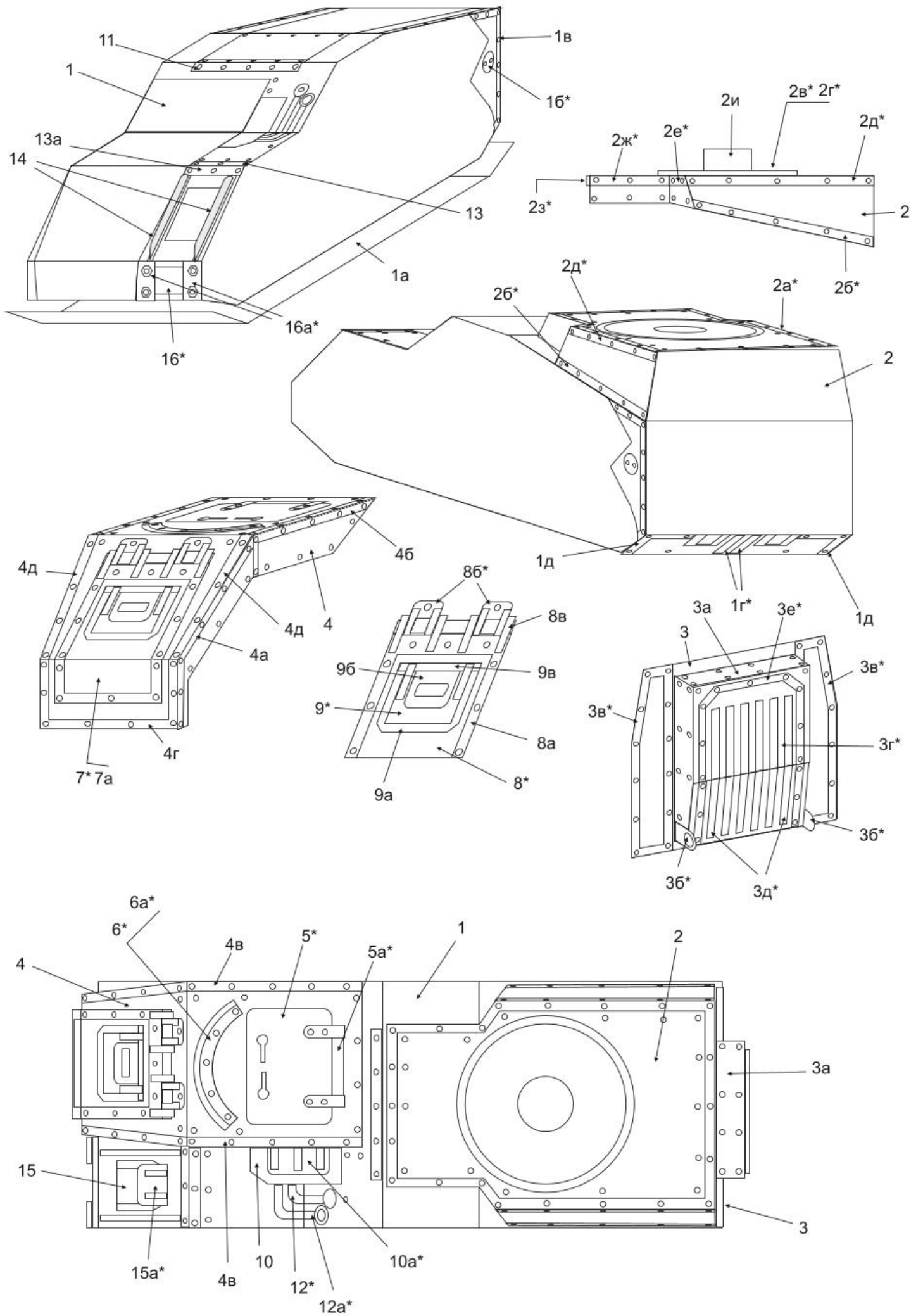

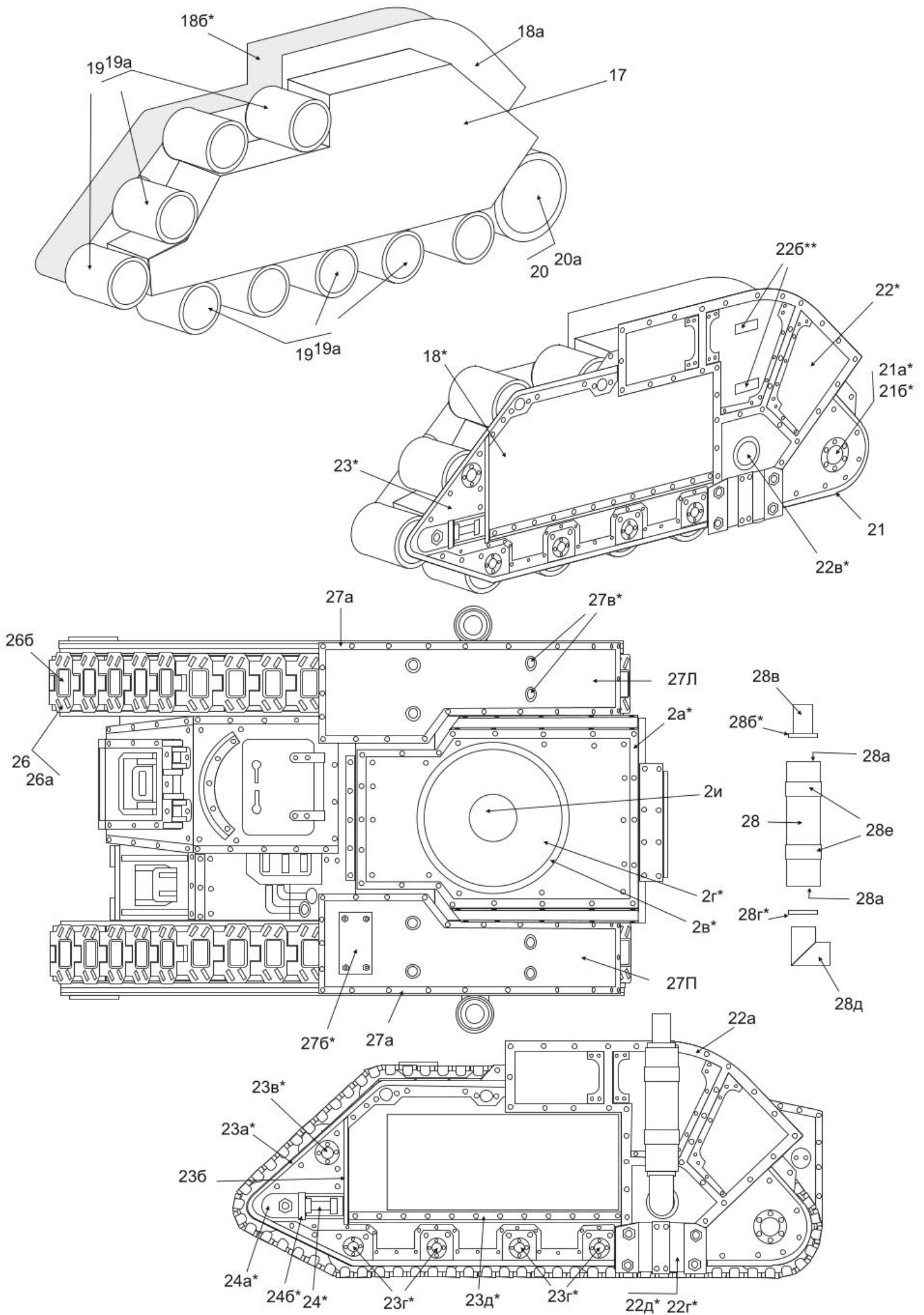

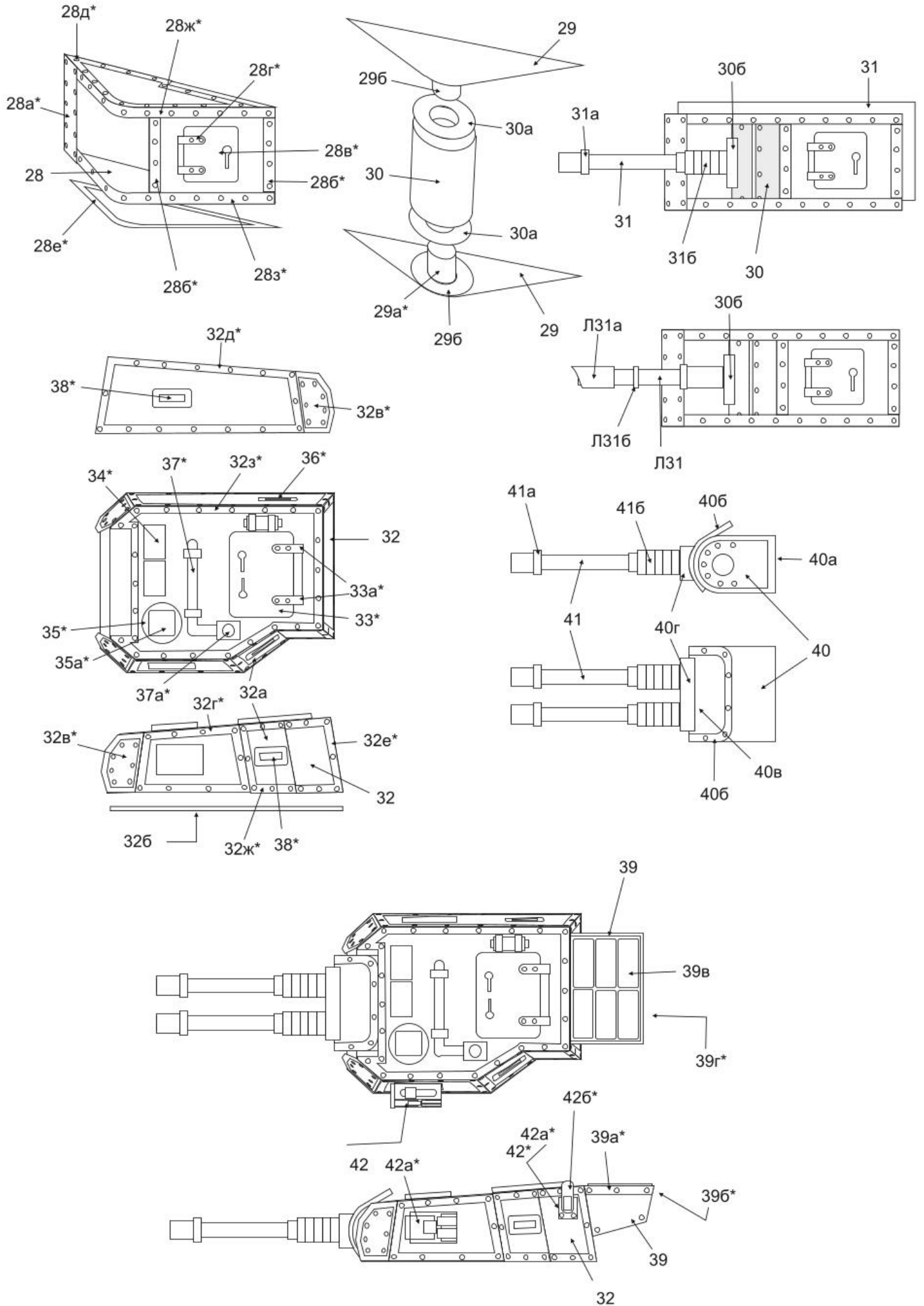

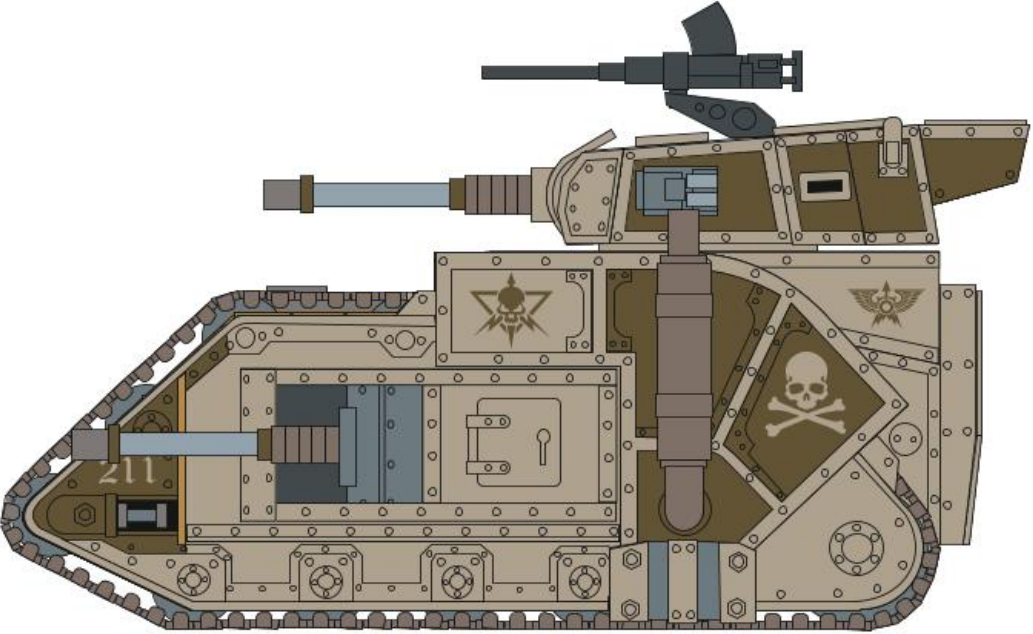
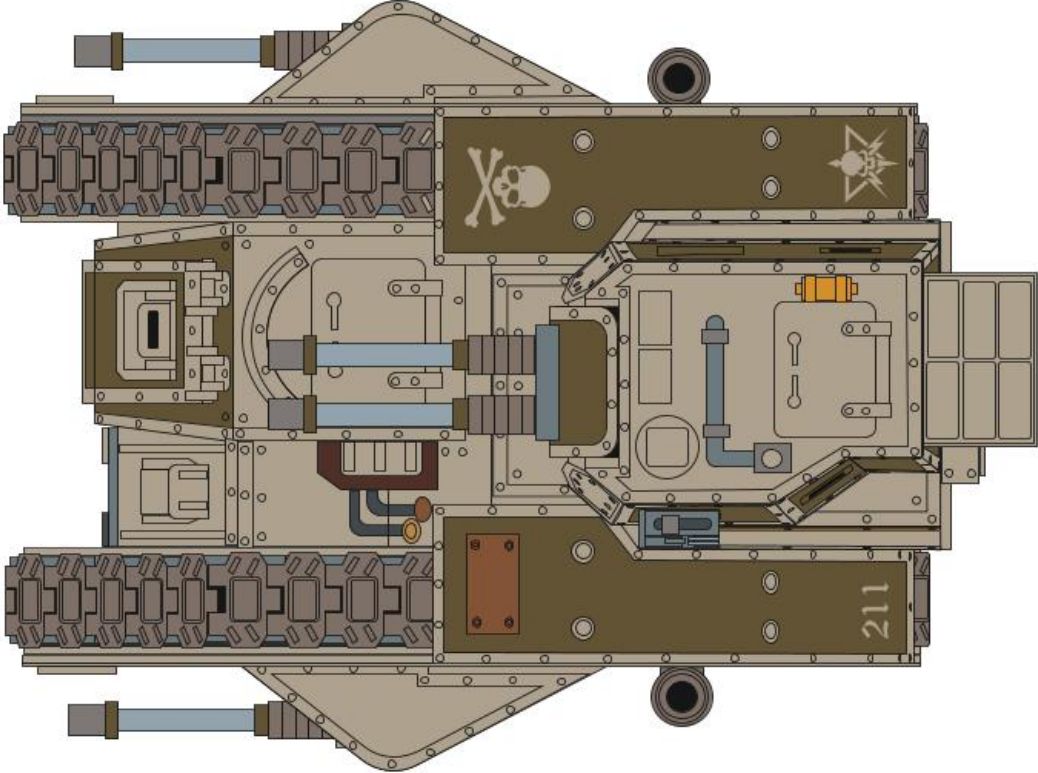

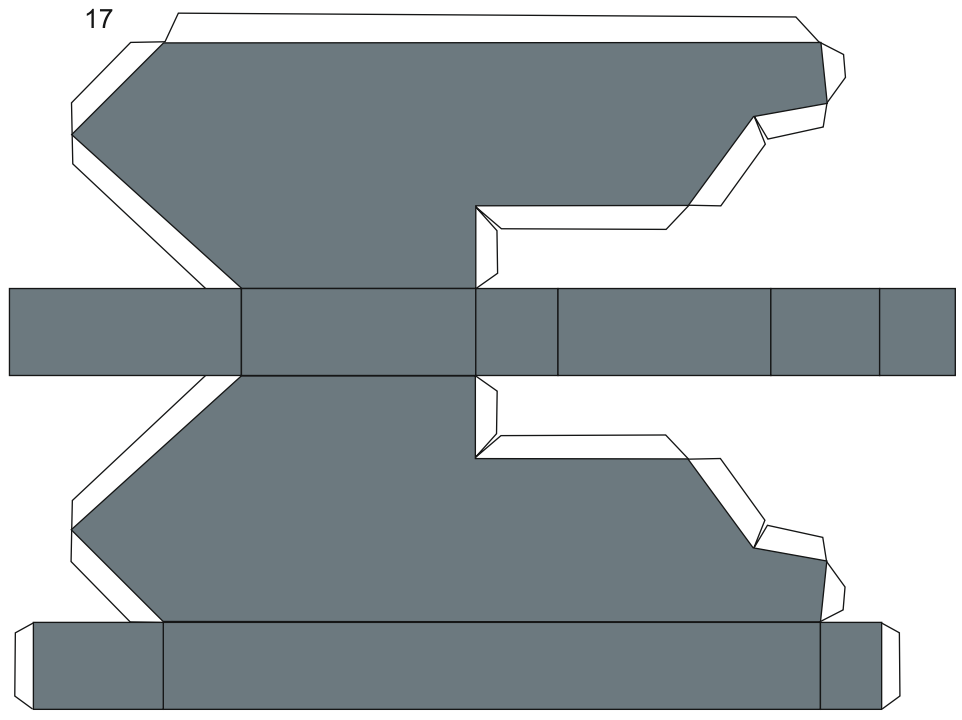
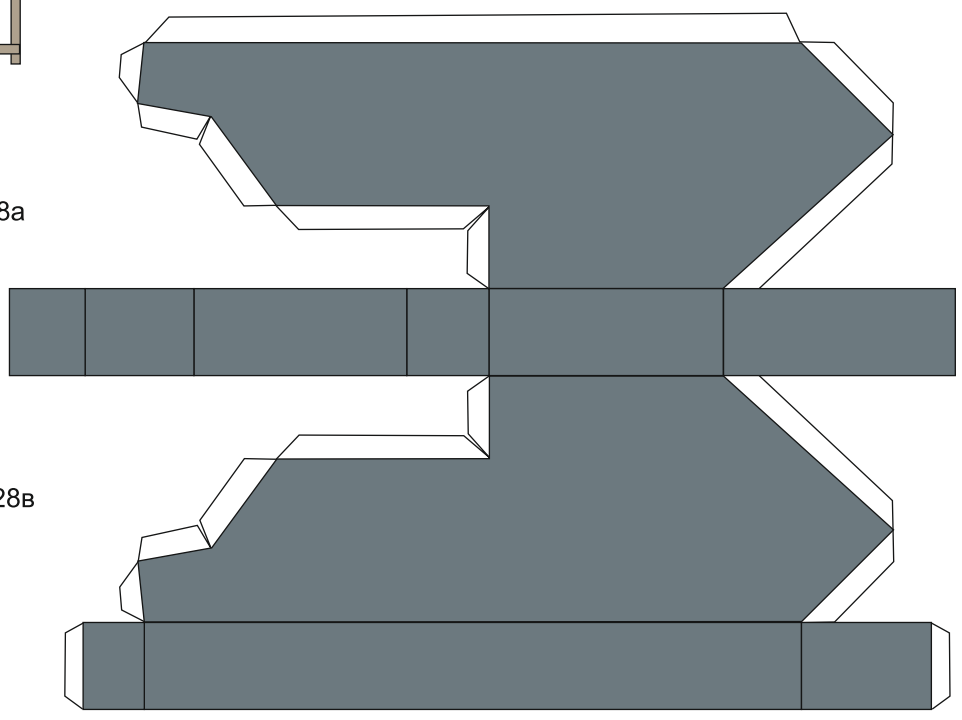
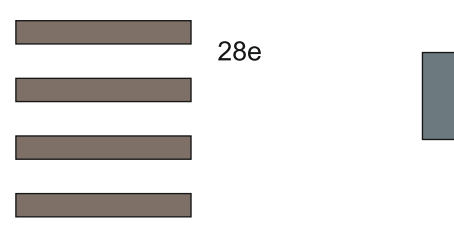
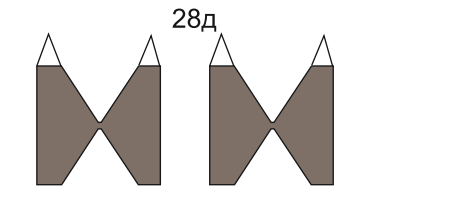
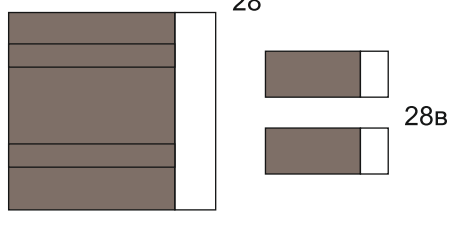
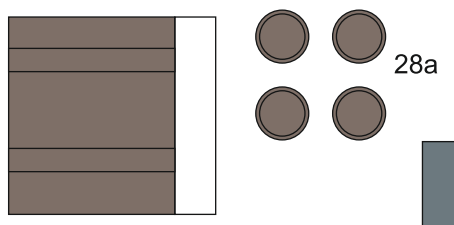
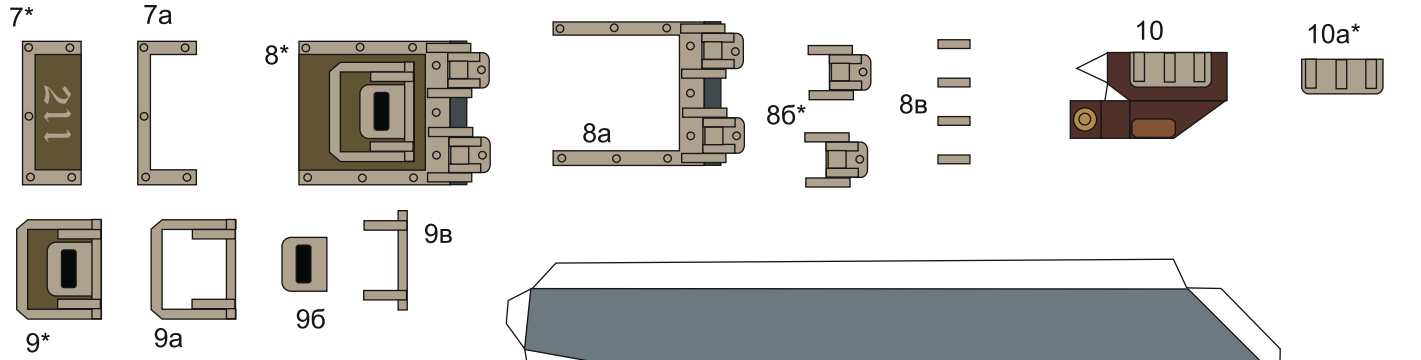
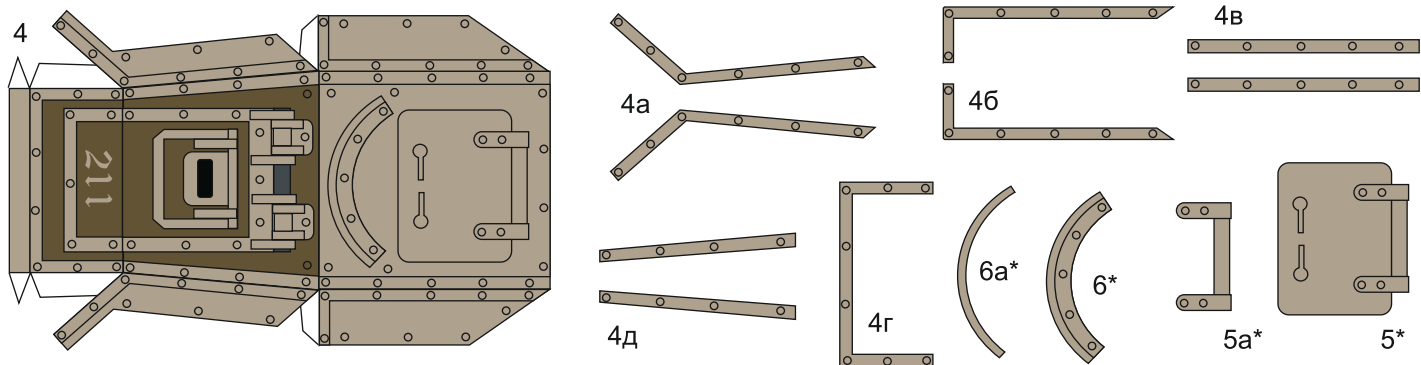

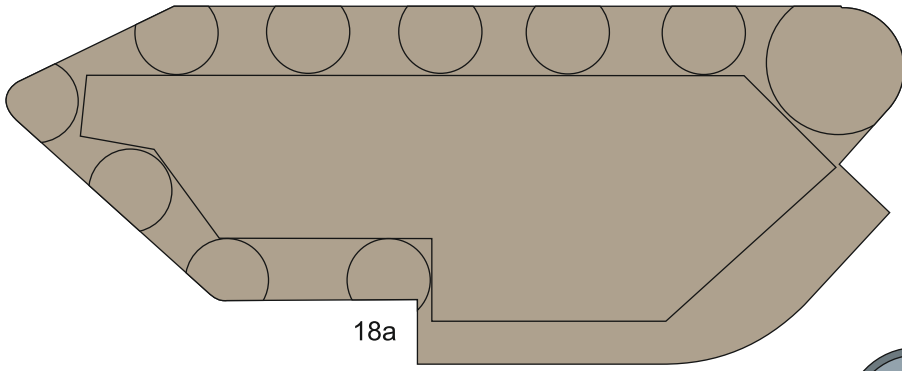

18a

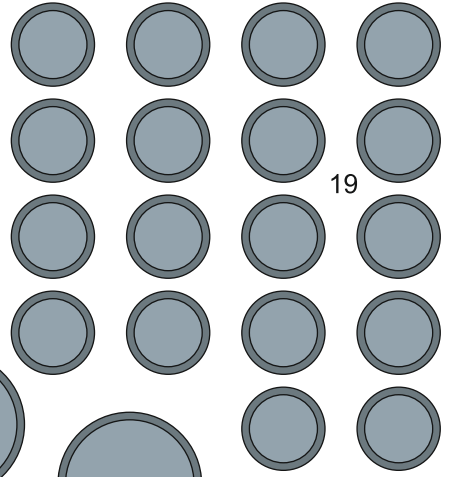

19

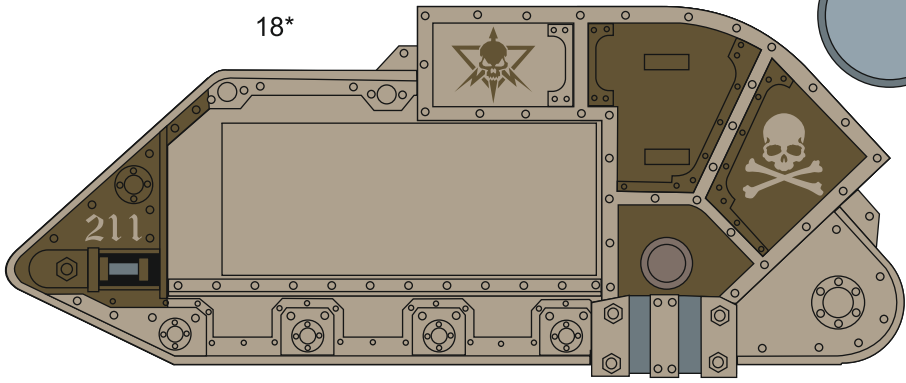

18*

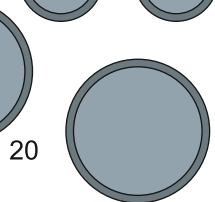

20

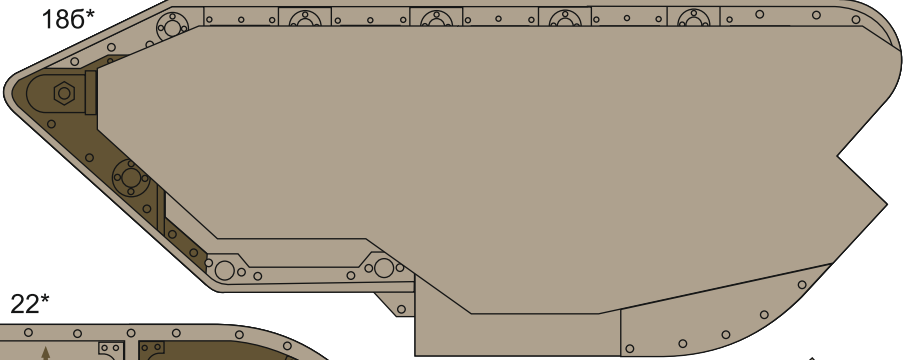

186*

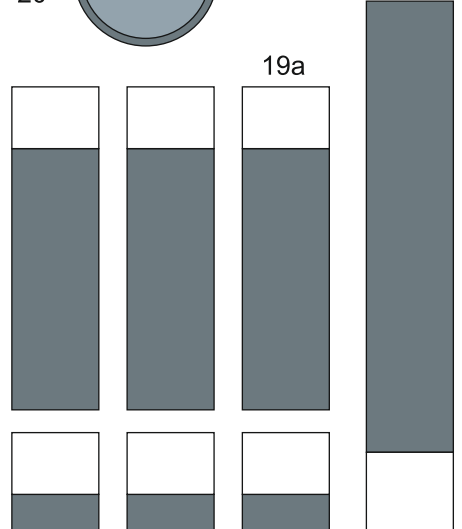

19a

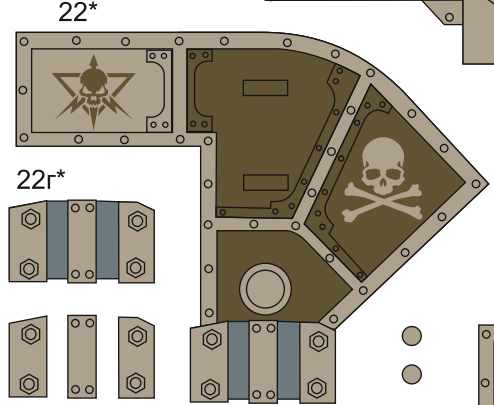

22*

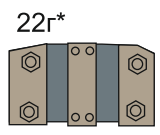

22Г*

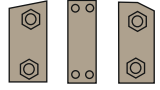

22Д*



22В*

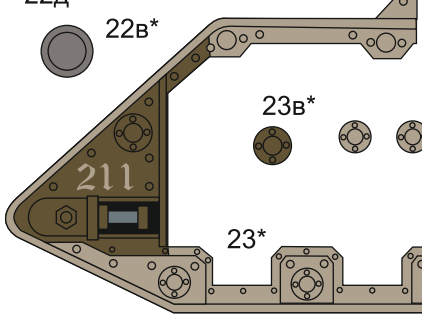

23*

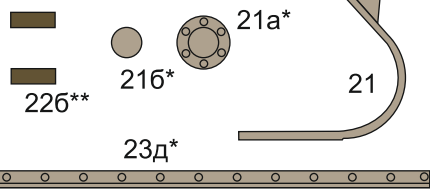

21a*

216*

226**

21

23Д*

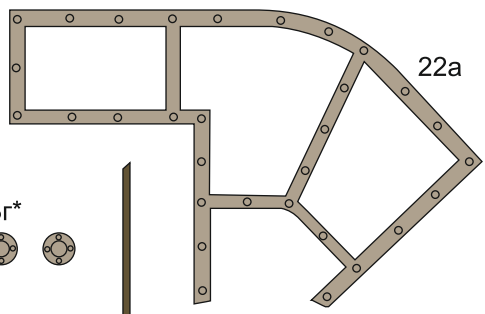

22a

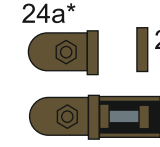

24a*

24*

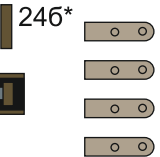

25Г

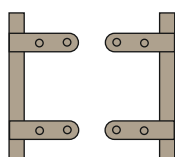

25Б*

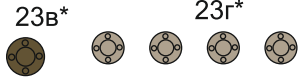

23Б*

23Г*

236

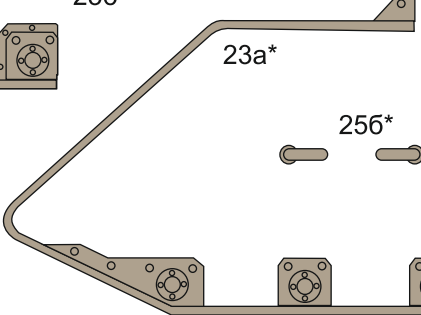

23a*



256*

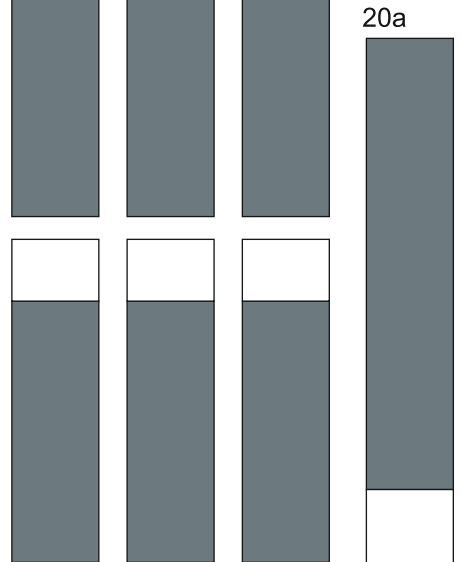

20a

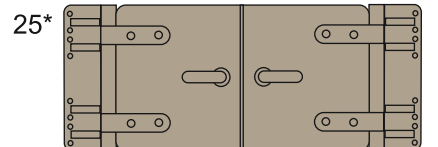

25*

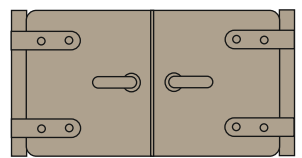

25a*

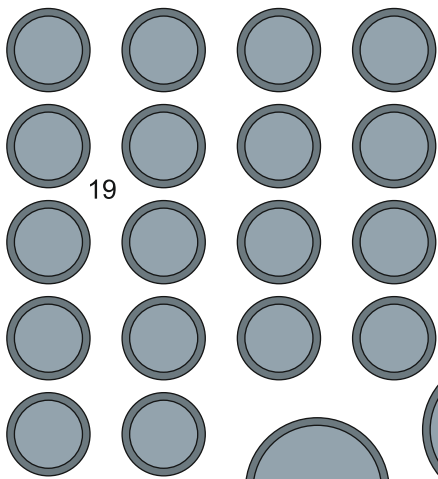

19

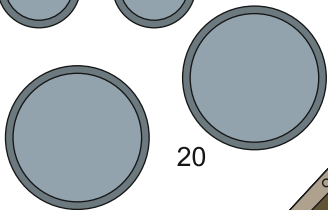

20

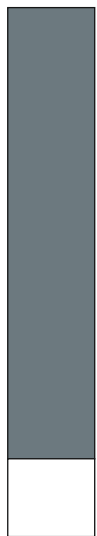

20a

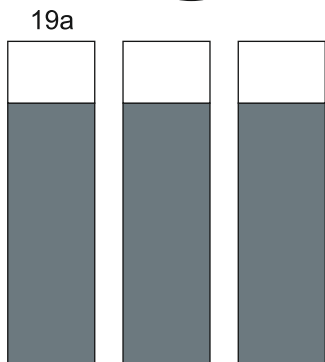

19a

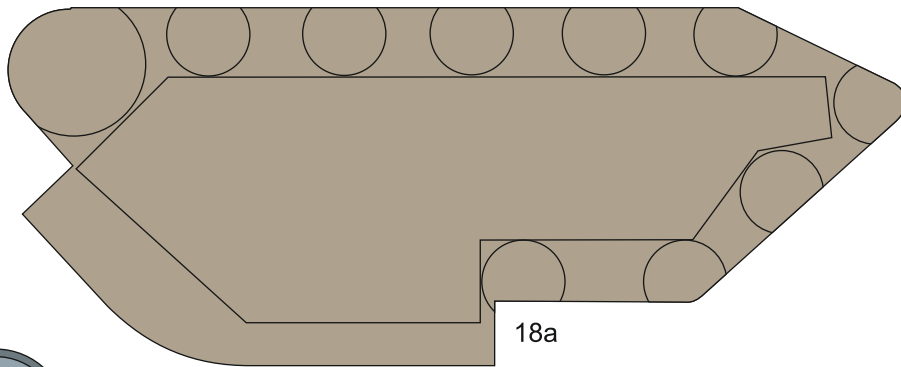
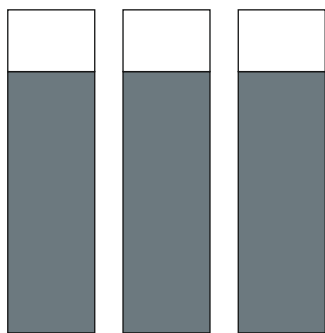
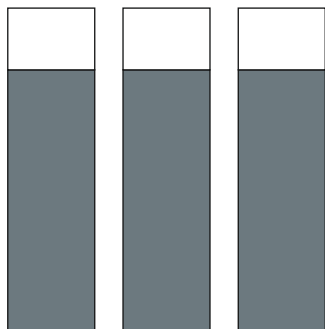

18a

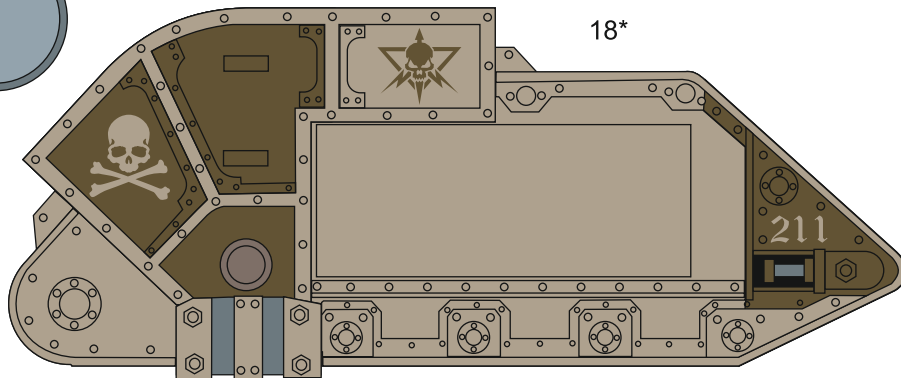

18*

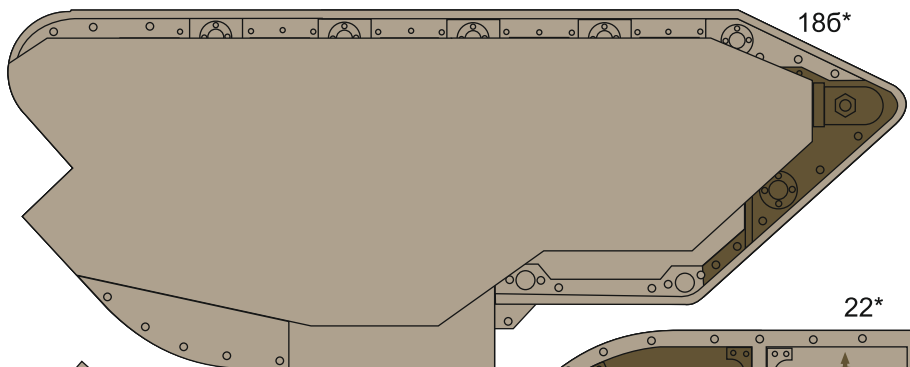

186*

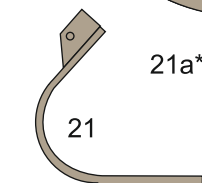

21

21a*

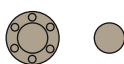

216*



226**



23д*

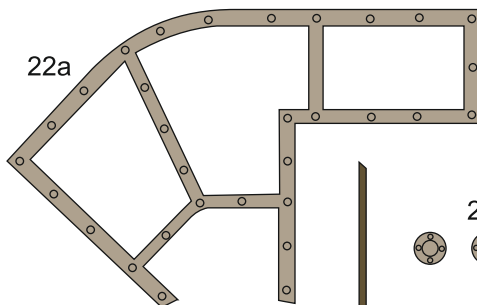

22a

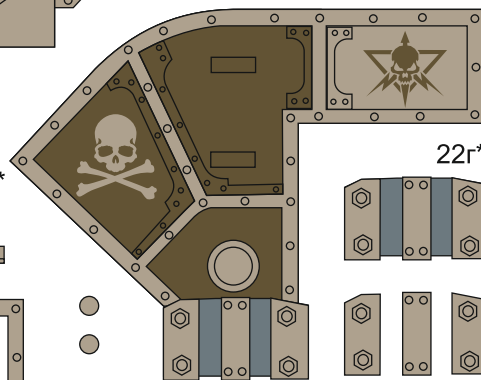

22*

22г*

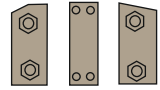
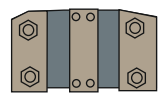

22д*

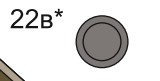

22в*

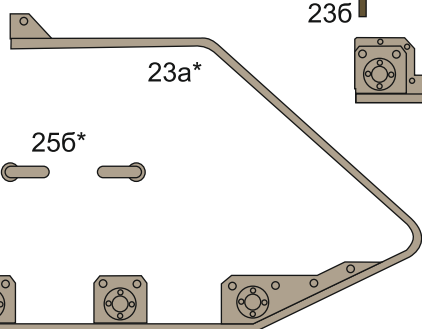

23a*

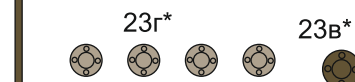

23г*

23в*

236

23в*

23г*

23д*

23е*

23ж*

23з*

23и*

23к*

23л*

23м*

23н*

23о*

23п*

23р*

23с*

23т*

23у*

23ф*

23х*

23ц*

23ч*

23ш*

23щ*

23ъ*

23ы*

23ь*

23а*

23б*

23в*

23г*

23д*

23е*

23ж*

23з*

23и*

23к*

23л*

23м*

23н*

23о*

23п*

23р*

23с*

23т*

23у*

23ф*

23х*

23ц*

23ч*

23ш*

23щ*

23ъ*

23ы*

23ь*

23а*

23б*

23в*

23г*

23д*

23е*

23ж*

23з*

23и*

23к*

23л*

23м*

23н*

23о*

23п*

23р*

23с*

23т*

23у*

23ф*

23х*

23ц*

23ч*

23ш*

23щ*

23ъ*

23ы*

23ь*

23а*

23б*

23в*

23г*

23д*

23е*

23ж*

23з*

23и*

23к*

23л*

23м*

23н*

23о*

23п*

23р*

23с*

23т*

23у*

23ф*

23х*

23ц*

23ч*

23ш*

23щ*

23ъ*

23ы*

23ь*

23а*

23б*

23в*

23г*

23д*

23е*

23ж*

23з*

23и*

23к*

23л*

23м*

23н*

23о*

23п*

23р*

23с*

23т*

23у*

23ф*

23х*

23ц*

23ч*

23ш*

23щ*

23ъ*

23ы*

23ь*

23а*

23б*

23в*

23г*

23д*

23е*

23ж*

23з*

23и*

23к*

23л*

23м*

23н*

23о*

23п*

23р*

23с*

23т*

23у*

23ф*

23х*

23ц*

23ч*

23ш*

23щ*

23ъ*

23ы*

23ь*

23а*

23б*

23в*

23г*

23д*

23е*

23ж*

23з*

23и*

23к*

23л*

23м*

23н*

23о*

23п*

23р*

23с*

23т*

23у*

23ф*

23х*

23ц*

23ч*

23ш*

23щ*

23ъ*

23ы*

23ь*

23а*

23б*

23в*

23г*

23д*

23е*

23ж*

23з*

23и*

23к*

23л*

23м*

23н*

23о*

23п*

23р*

23с*

23т*

23у*

23ф*

23х*

23ц*

23ч*

23ш*

23щ*

23ъ*

23ы*

23ь*

23а*

23б*

23в*

23г*

23д*

23е*

23ж*

23з*

23и*

23к*

23л*

23м*

23н*

23о*

23п*

23р*

23с*

23т*

23у*

23ф*

23х*

23ц*

23ч*

23ш*

23щ*

23ъ*

23ы*

23ь*

23а*

23б*

23в*

23г*

23д*

23е*

23ж*

23з*

23и*

23к*

23л*

23м*

23н*

23о*

23п*

23р*

23с*

23т*

23у*

23ф*

23х*

23ц*

23ч*

23ш*

23щ*

23ъ*

23ы*

23ь*

23а*

23б*

23в*

23г*

23д*

23е*

23ж*

23з*

23и*

23к*

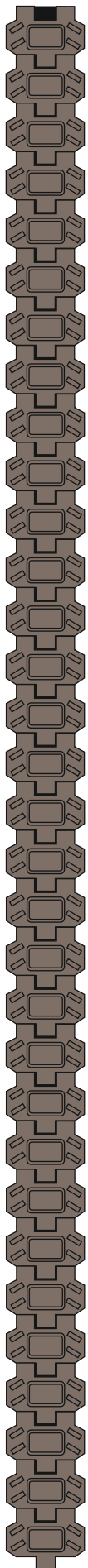

26

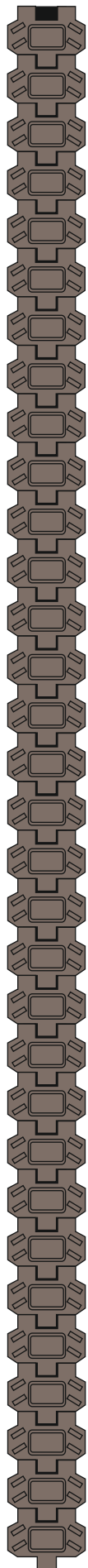

26a



266

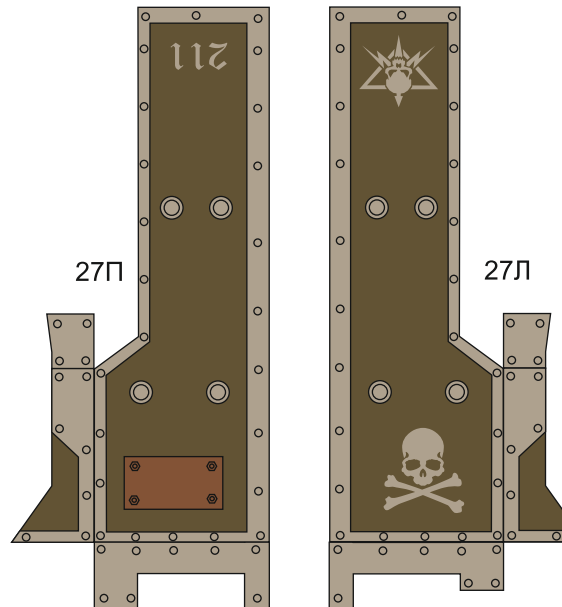
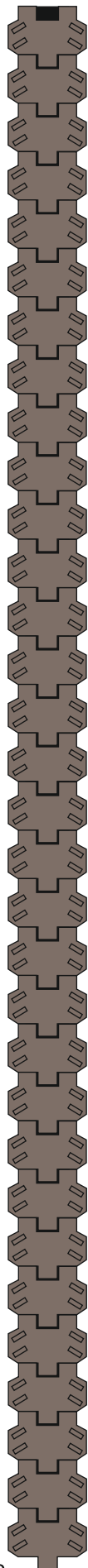

27П

27Л

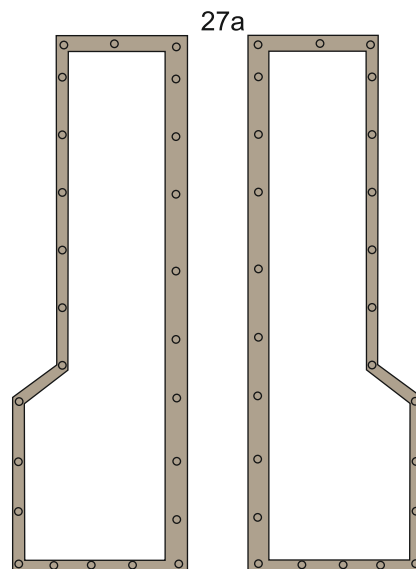

27a

276*



27в*

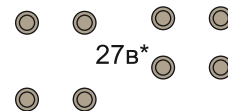

27г

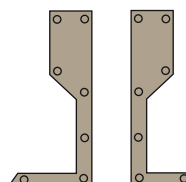

27д

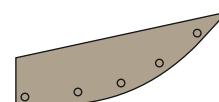
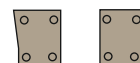

27e

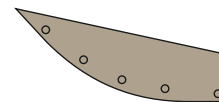

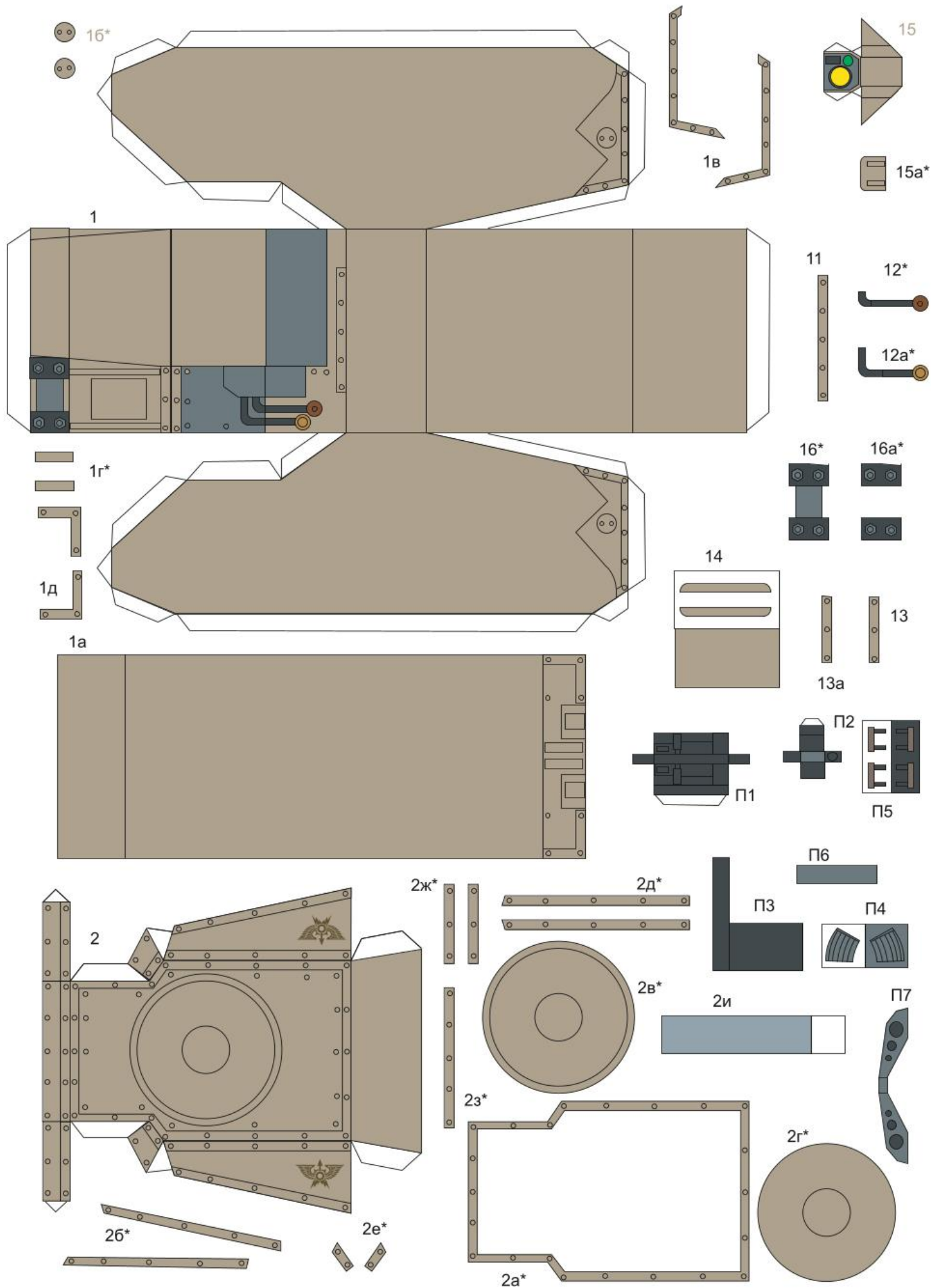

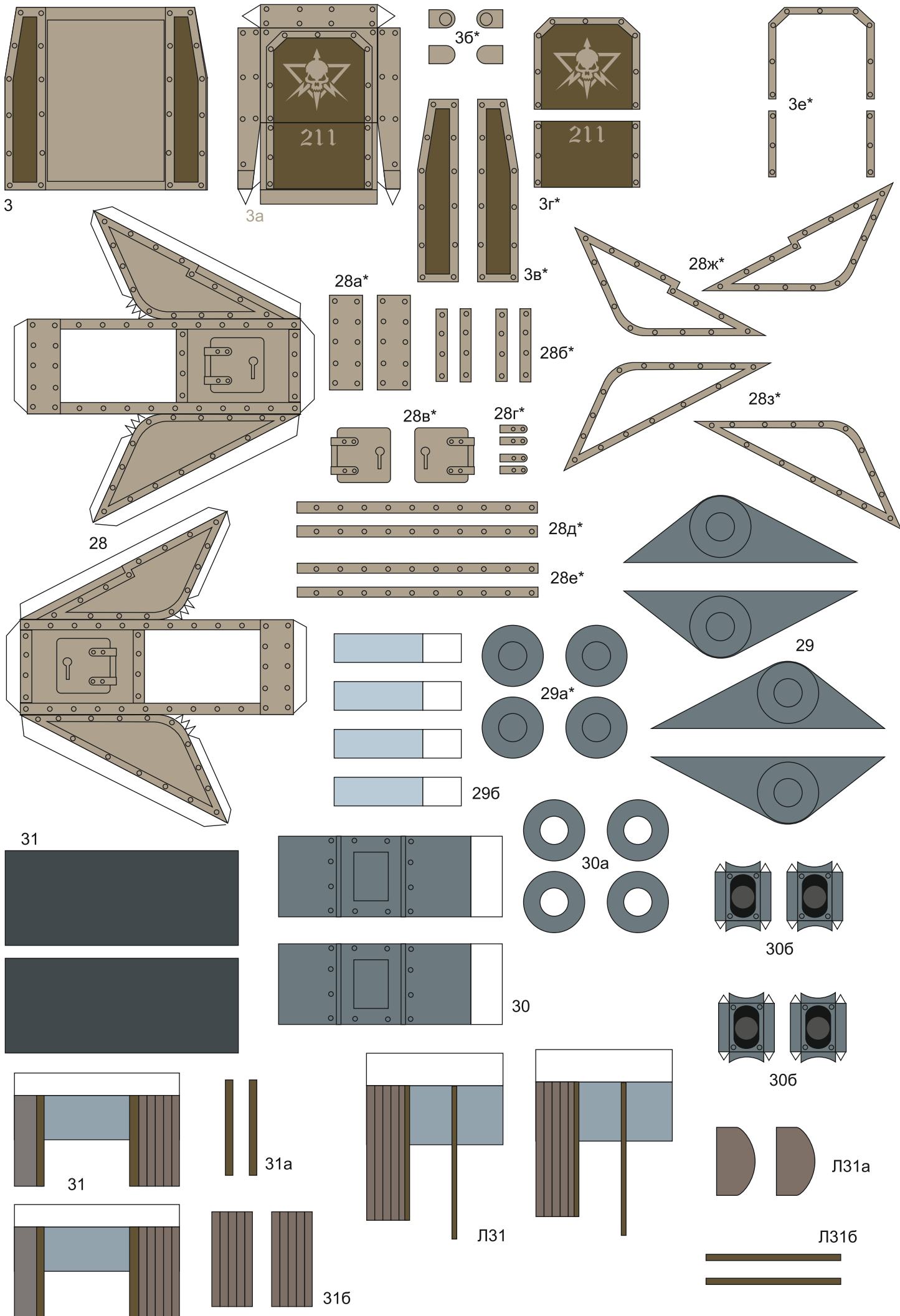

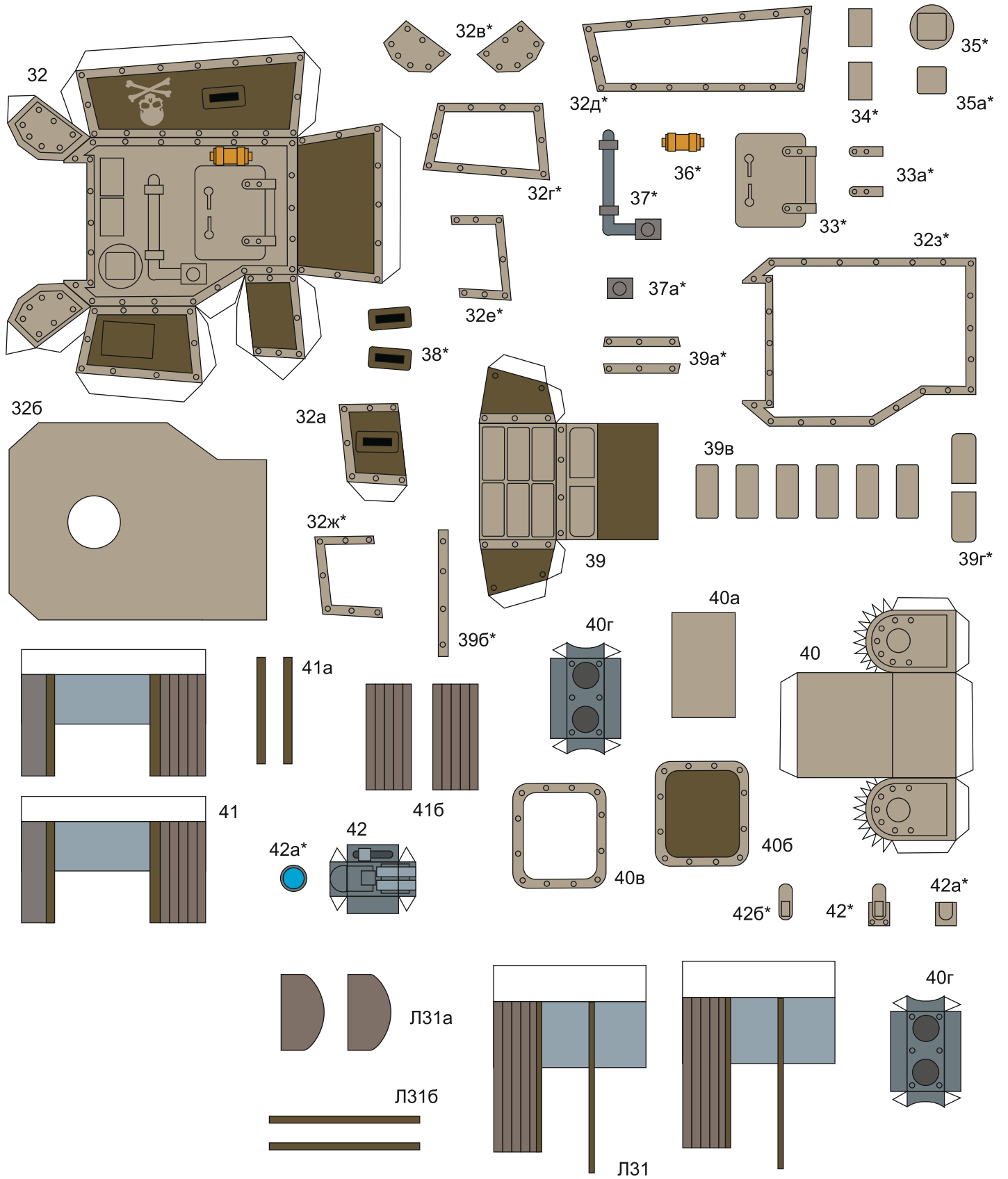

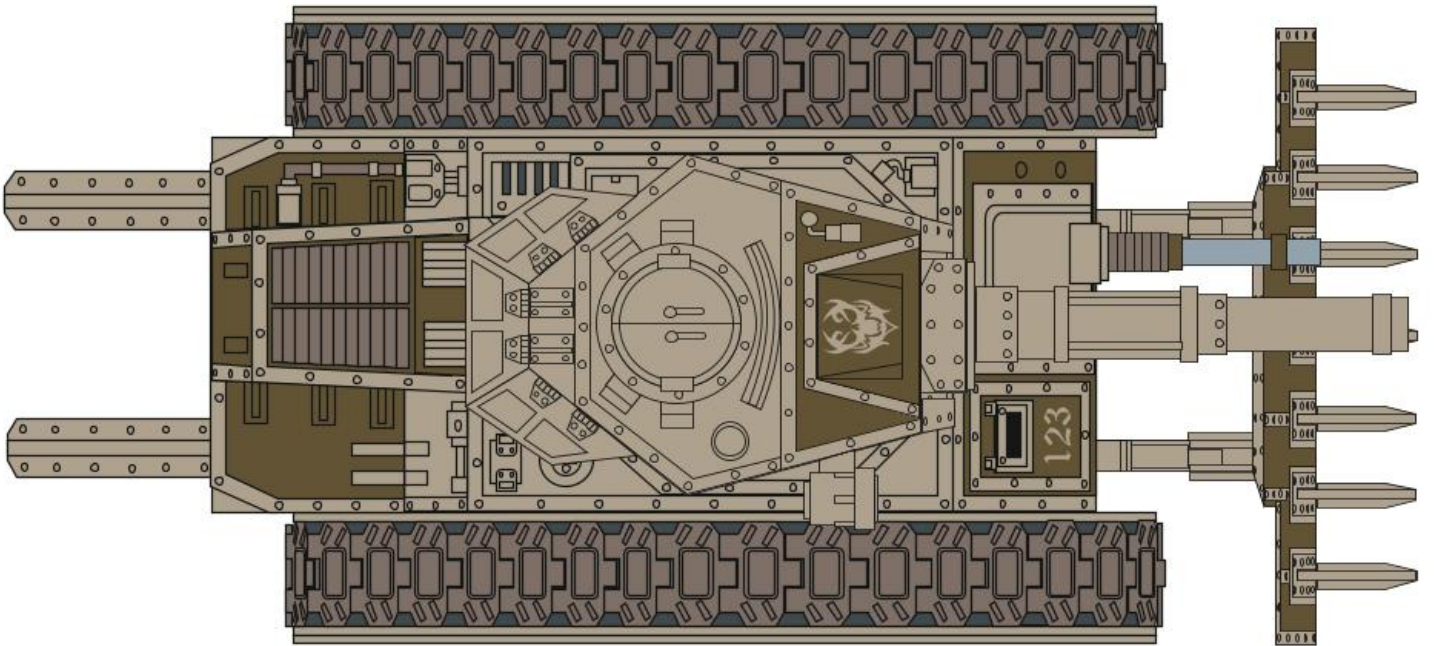
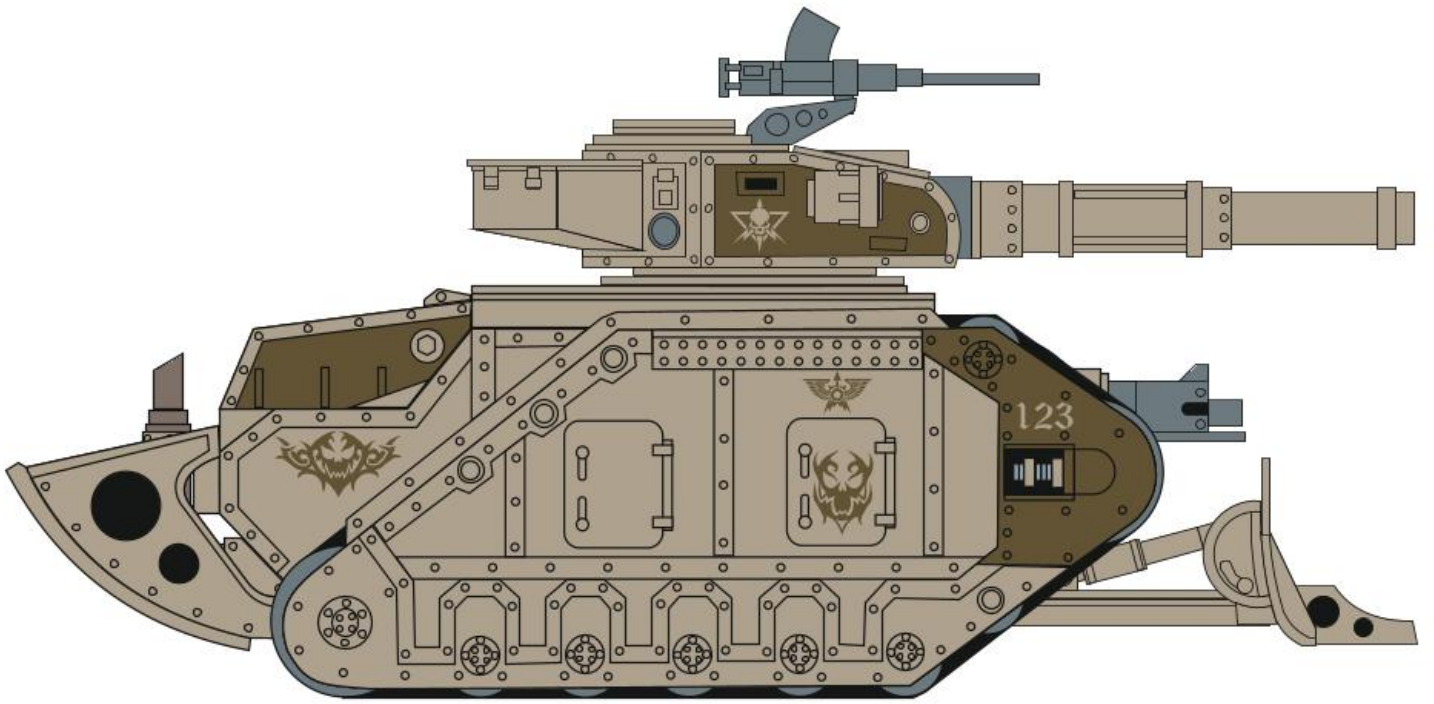

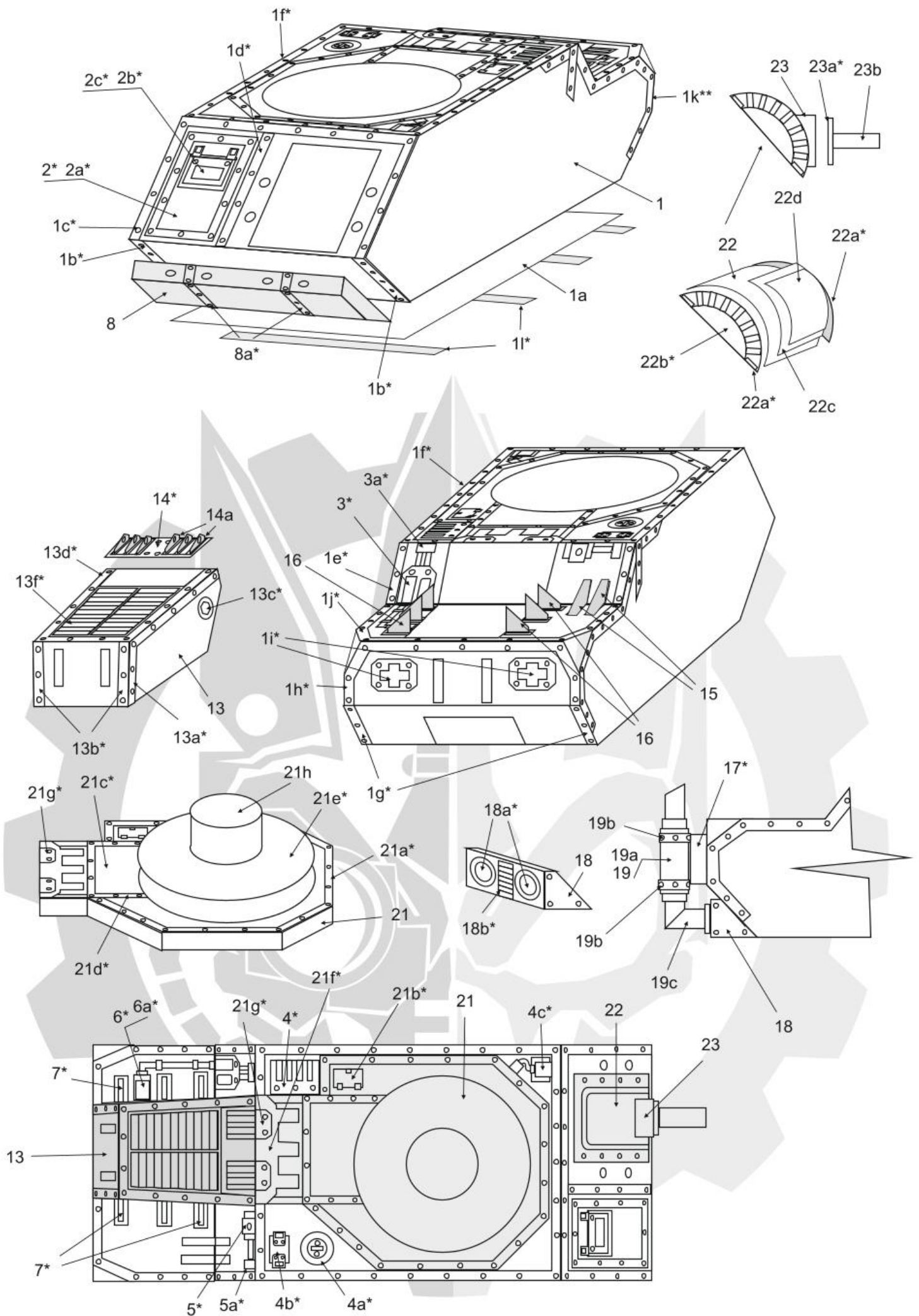

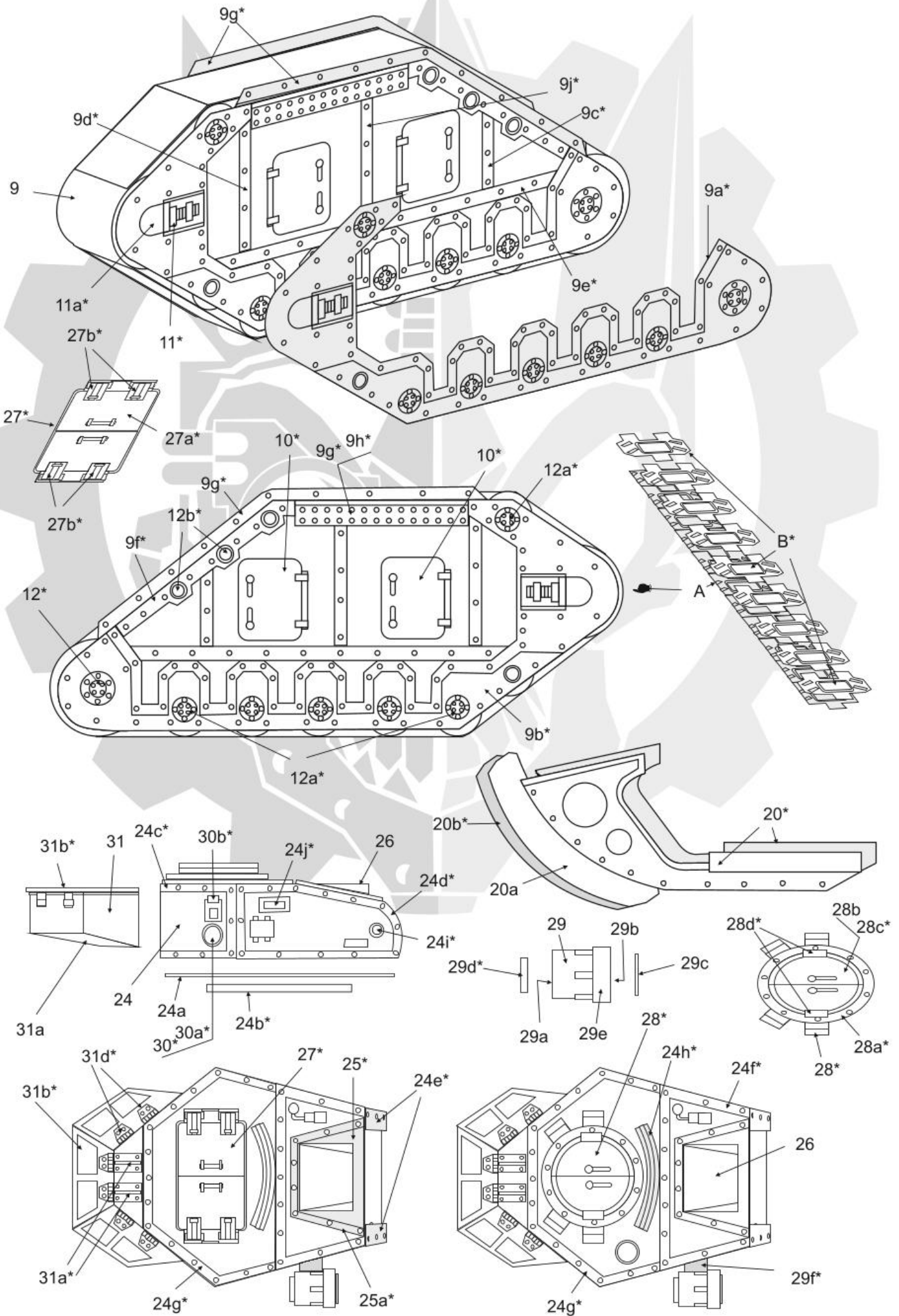

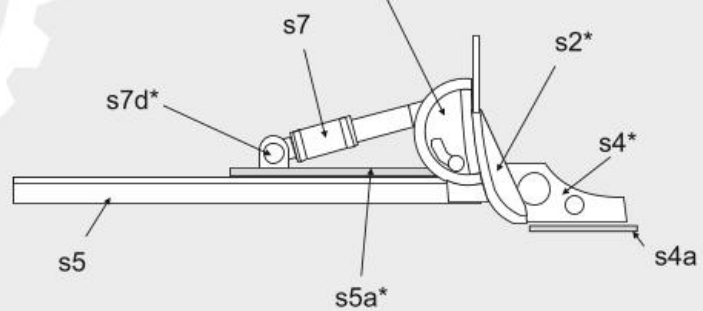
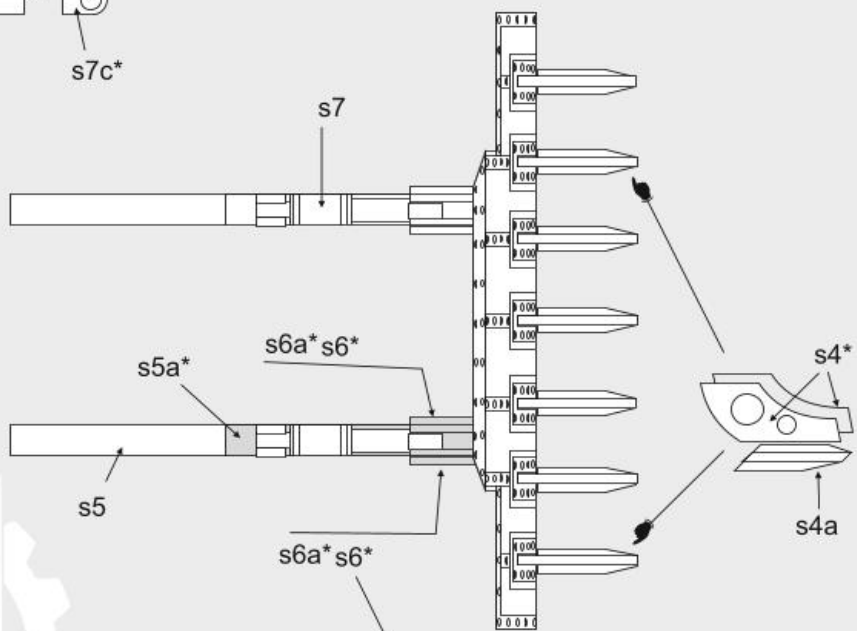
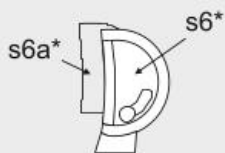
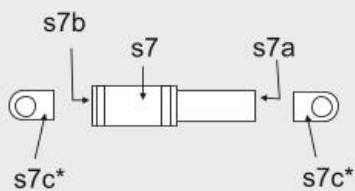
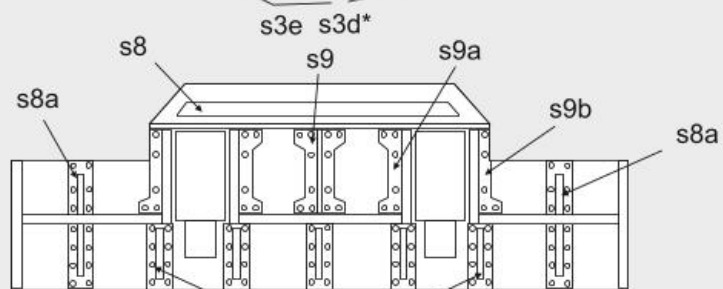
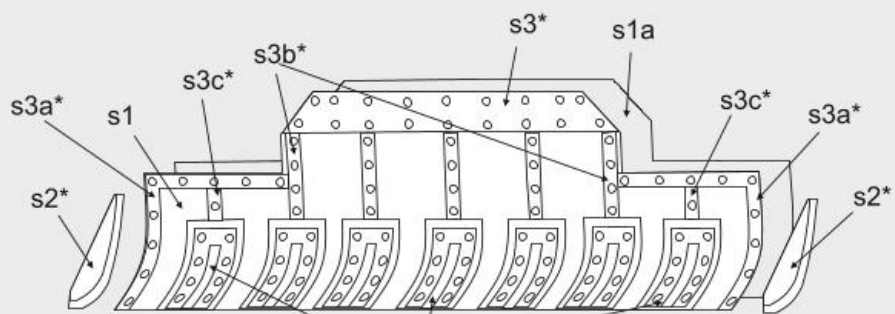

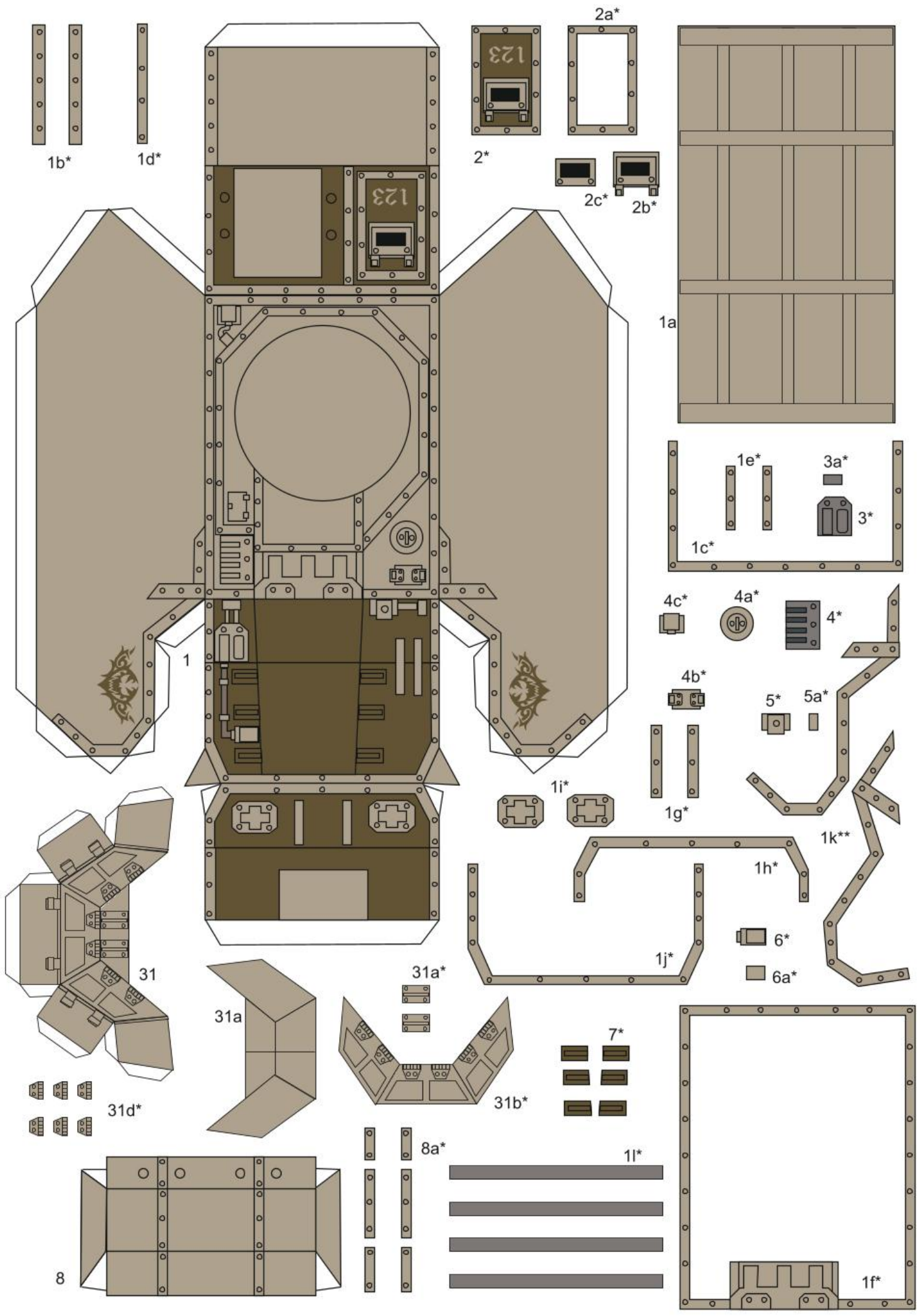

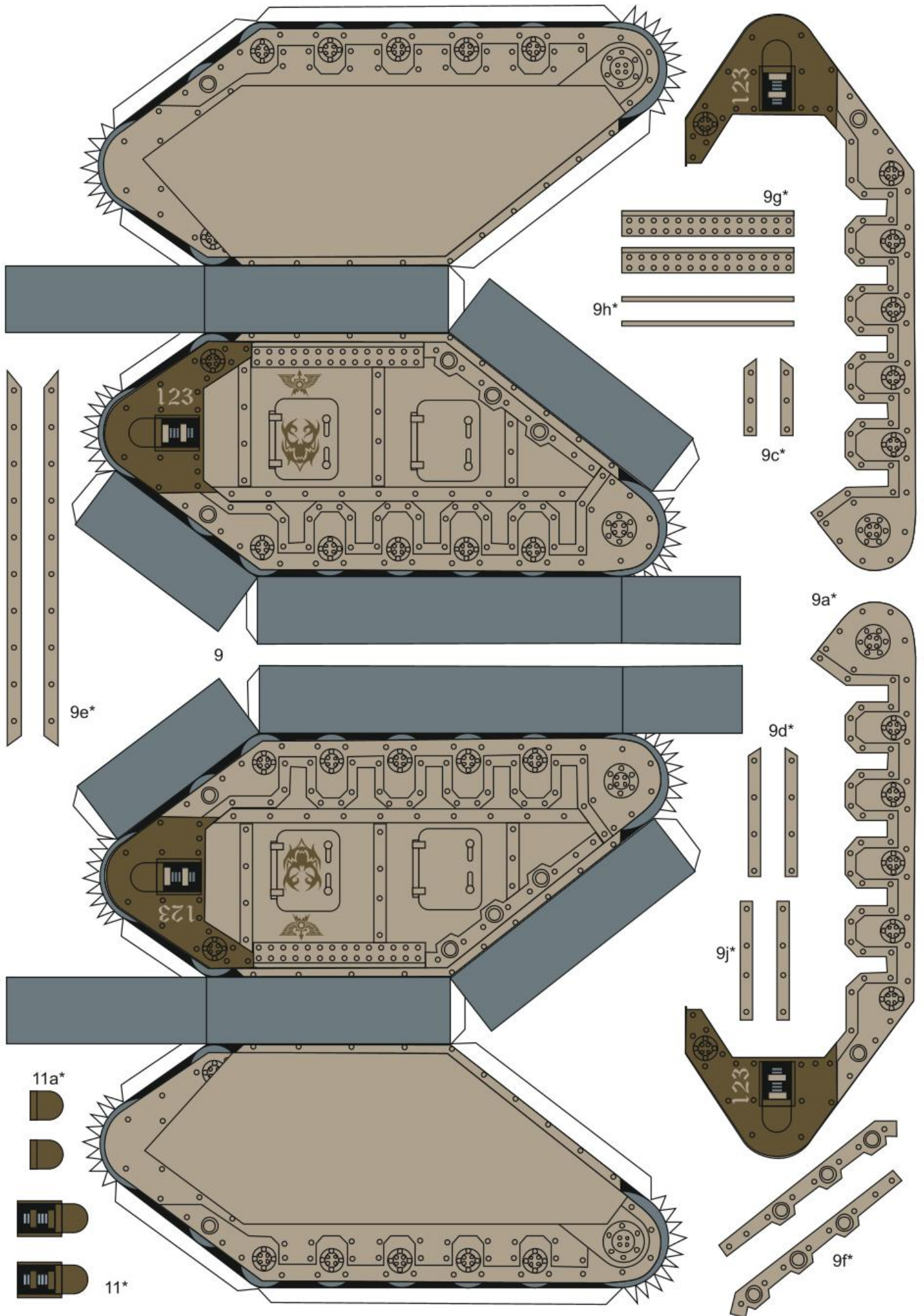

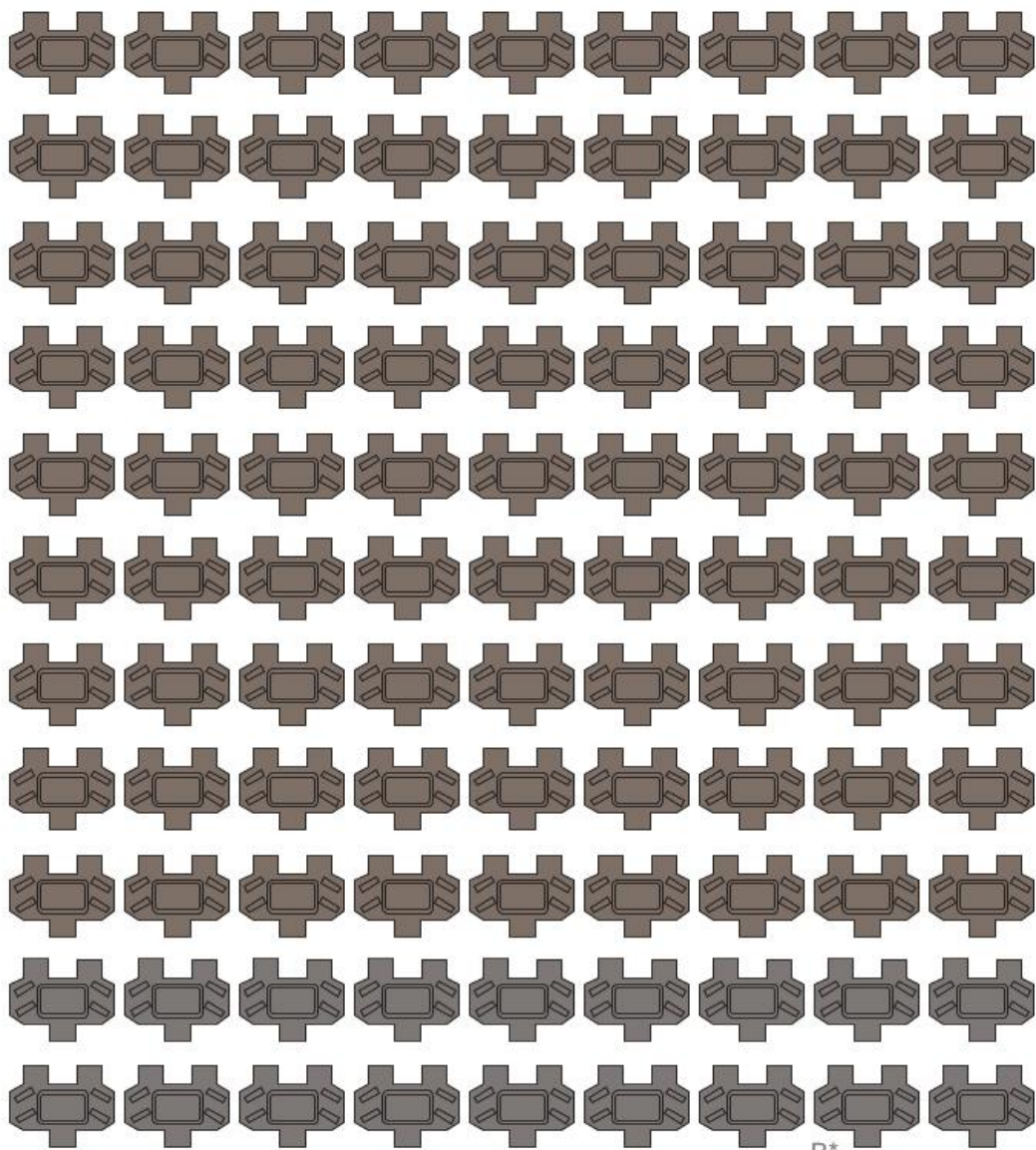

B*

A

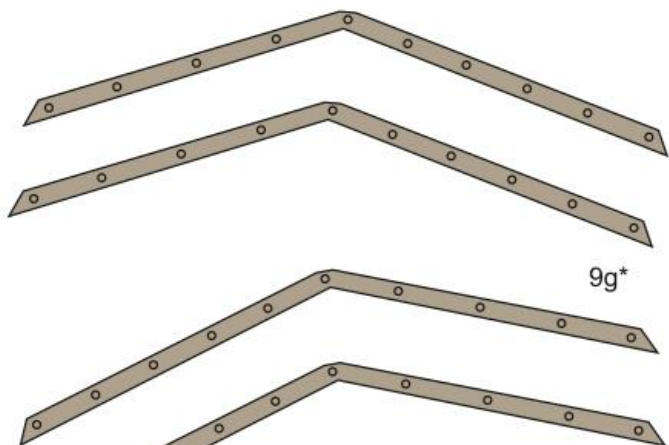
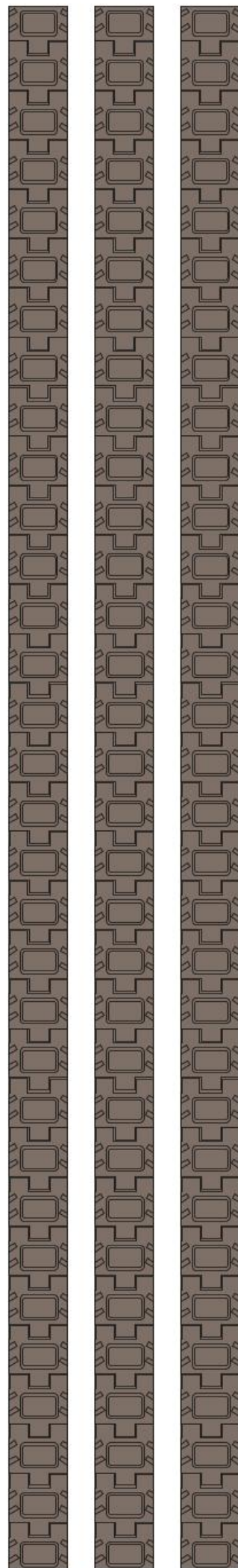

9g*

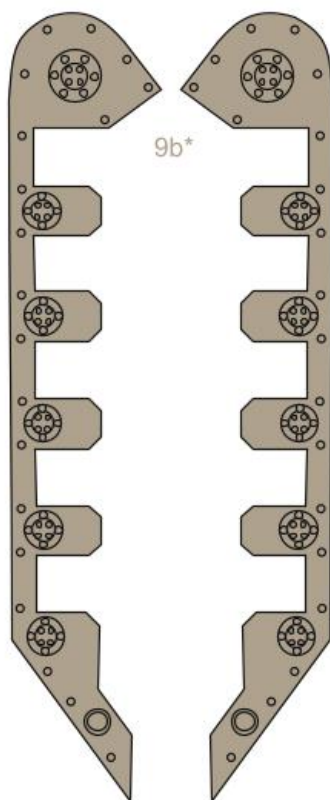

9b*

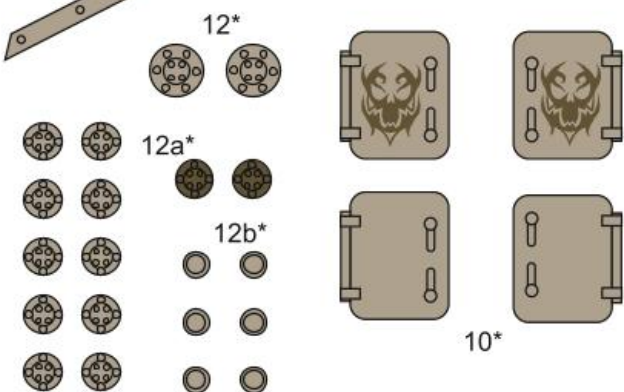

12*

12a*

12b*

10*

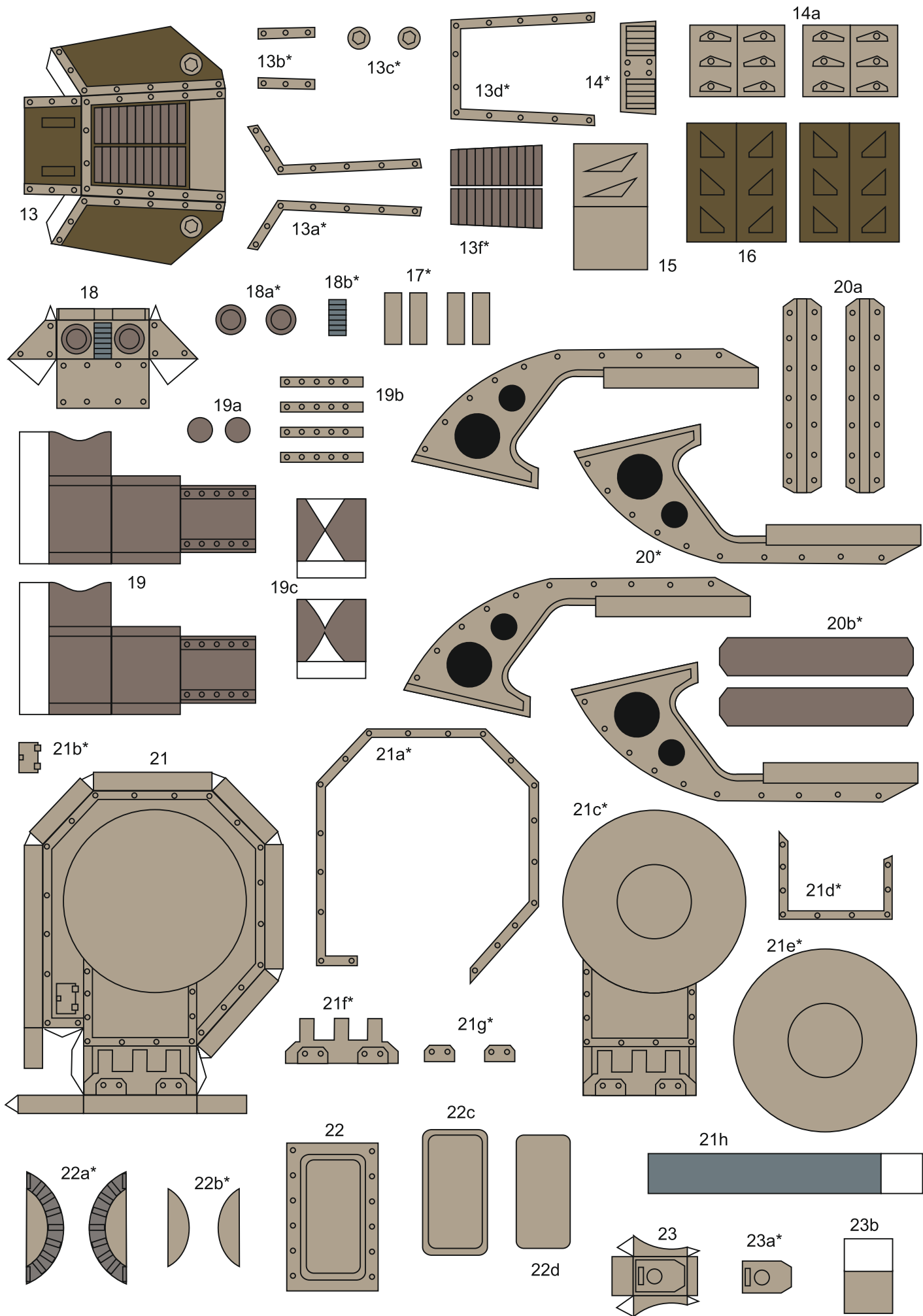

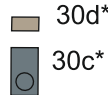
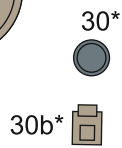
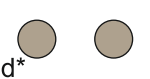
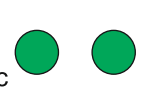
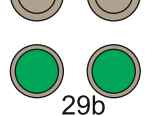
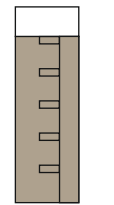
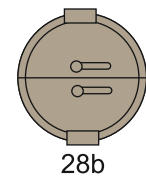
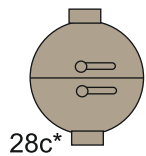
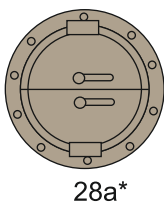
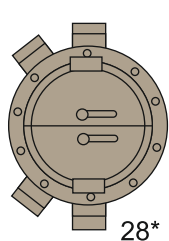
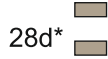
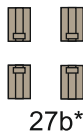
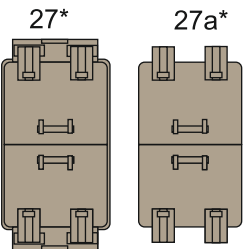
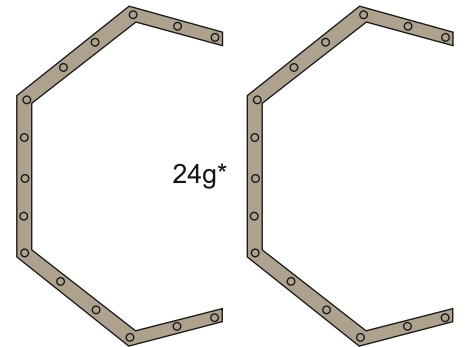
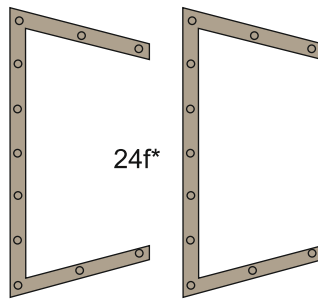
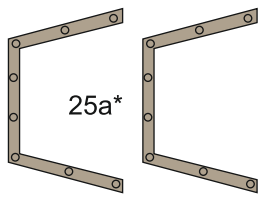
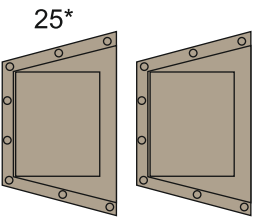
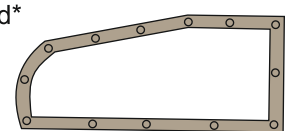
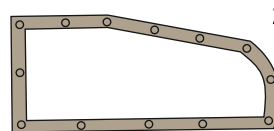
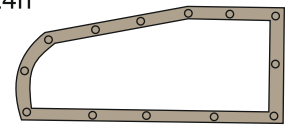
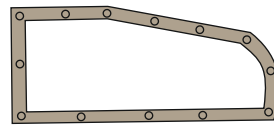
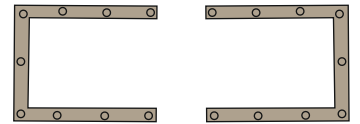
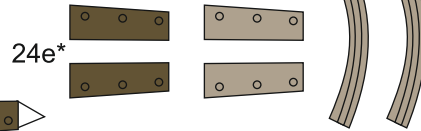
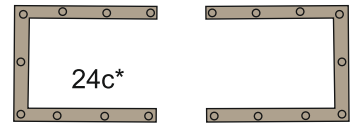
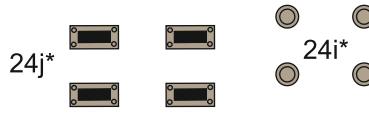
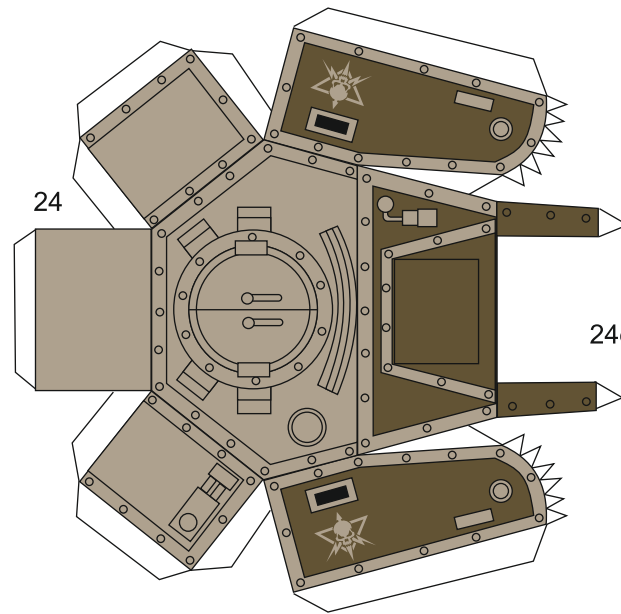
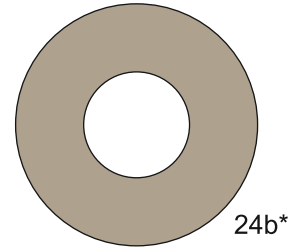
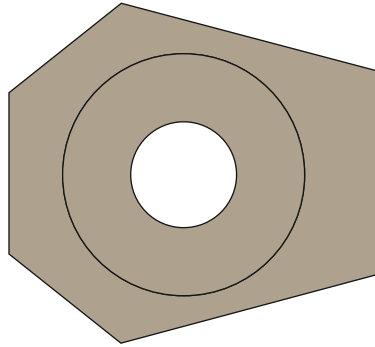
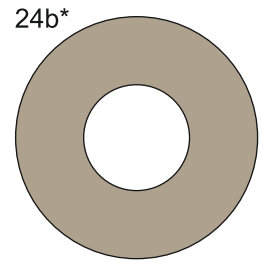
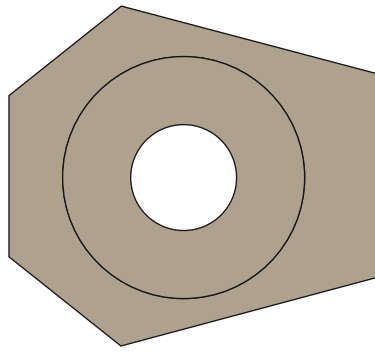
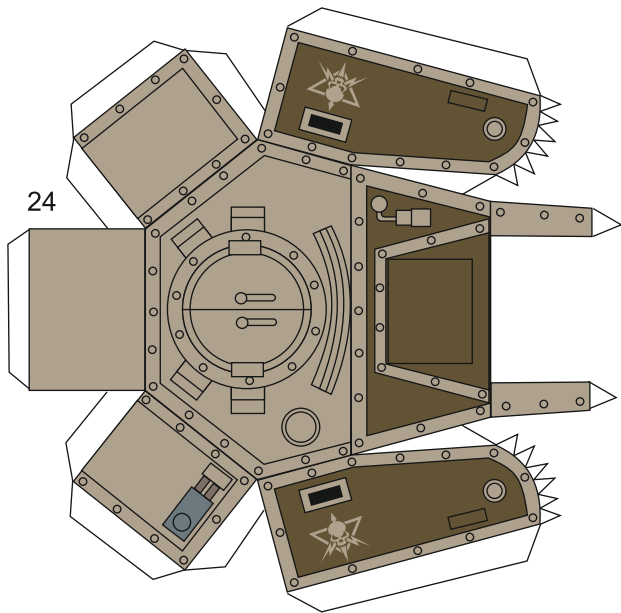

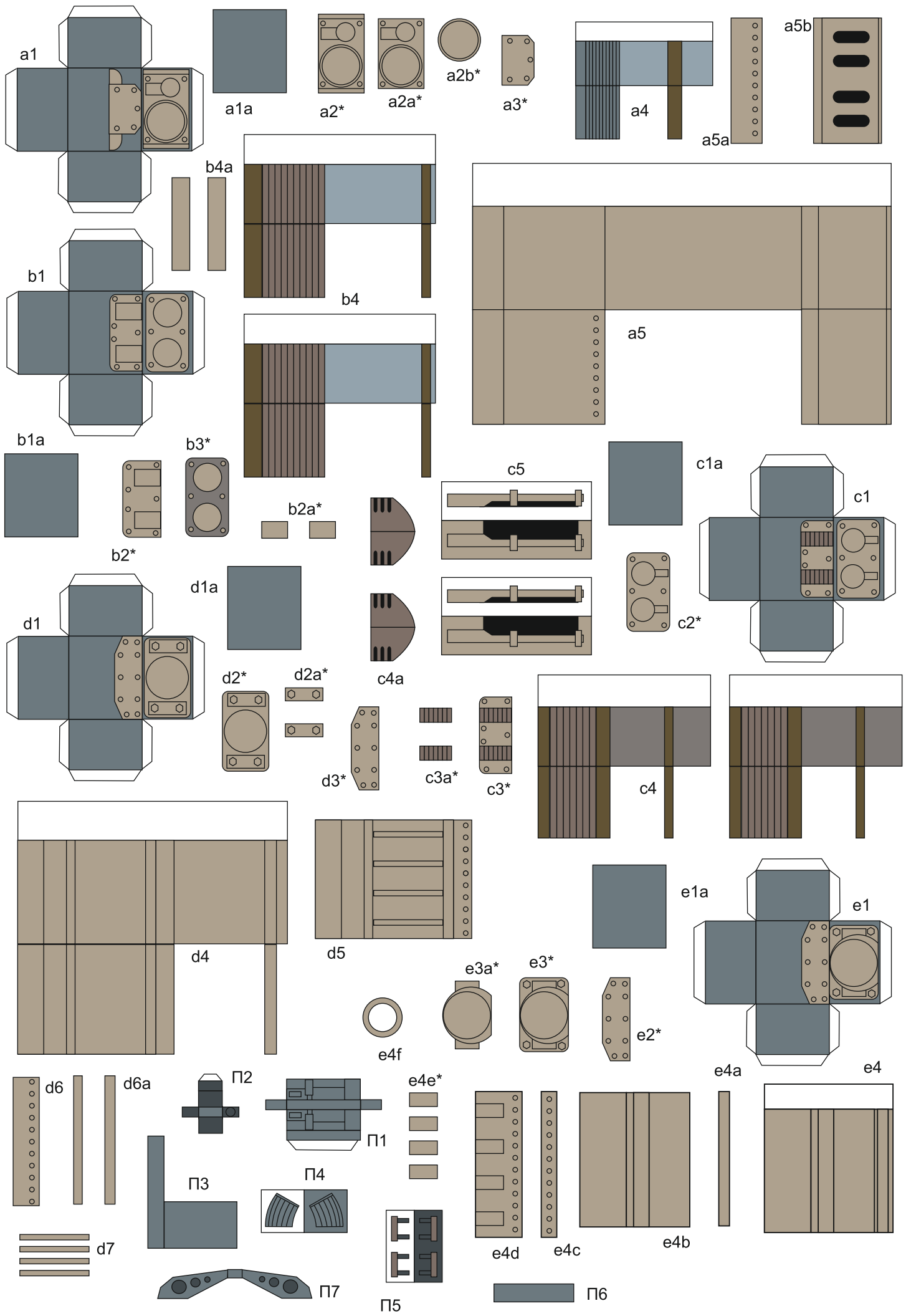

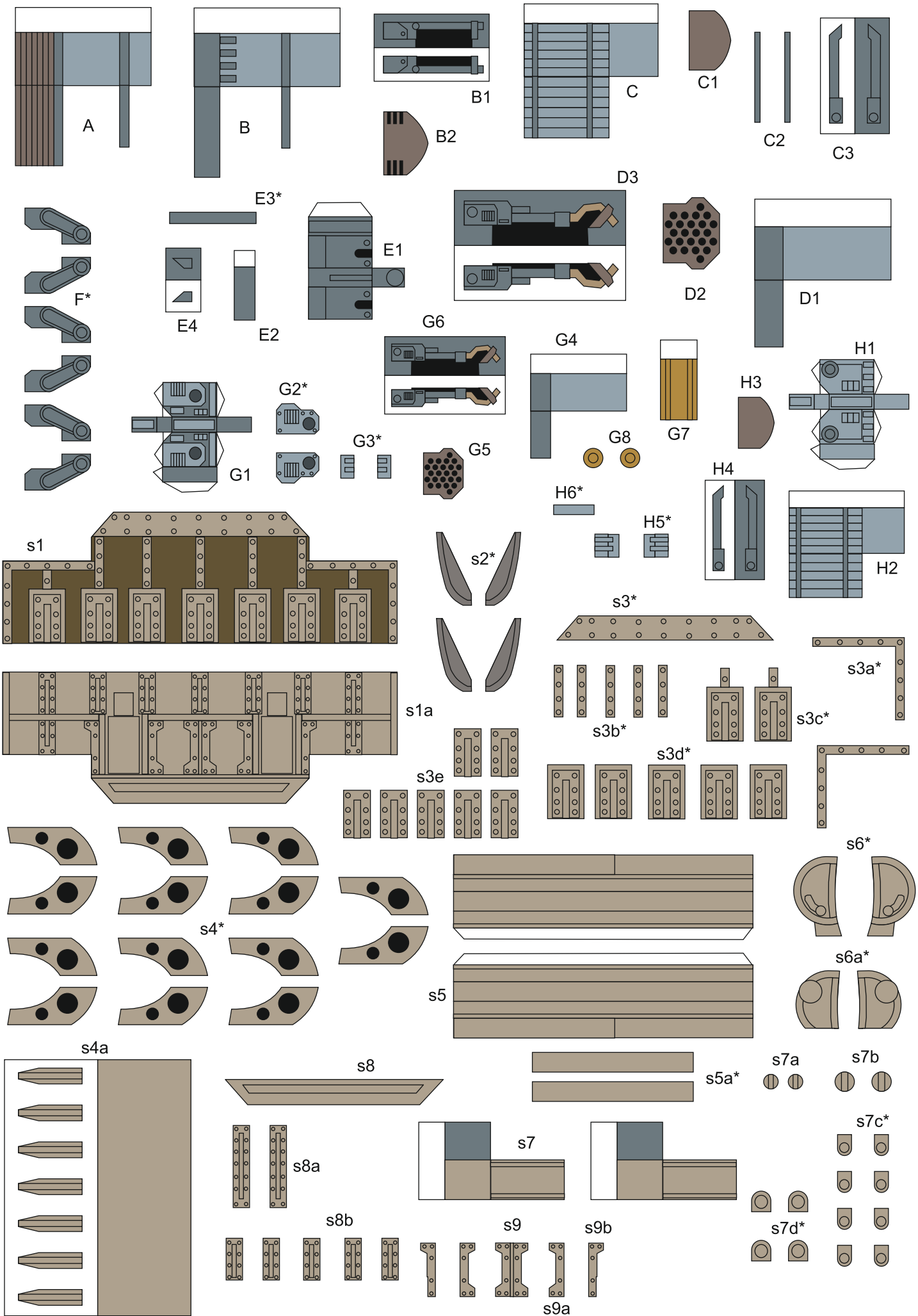

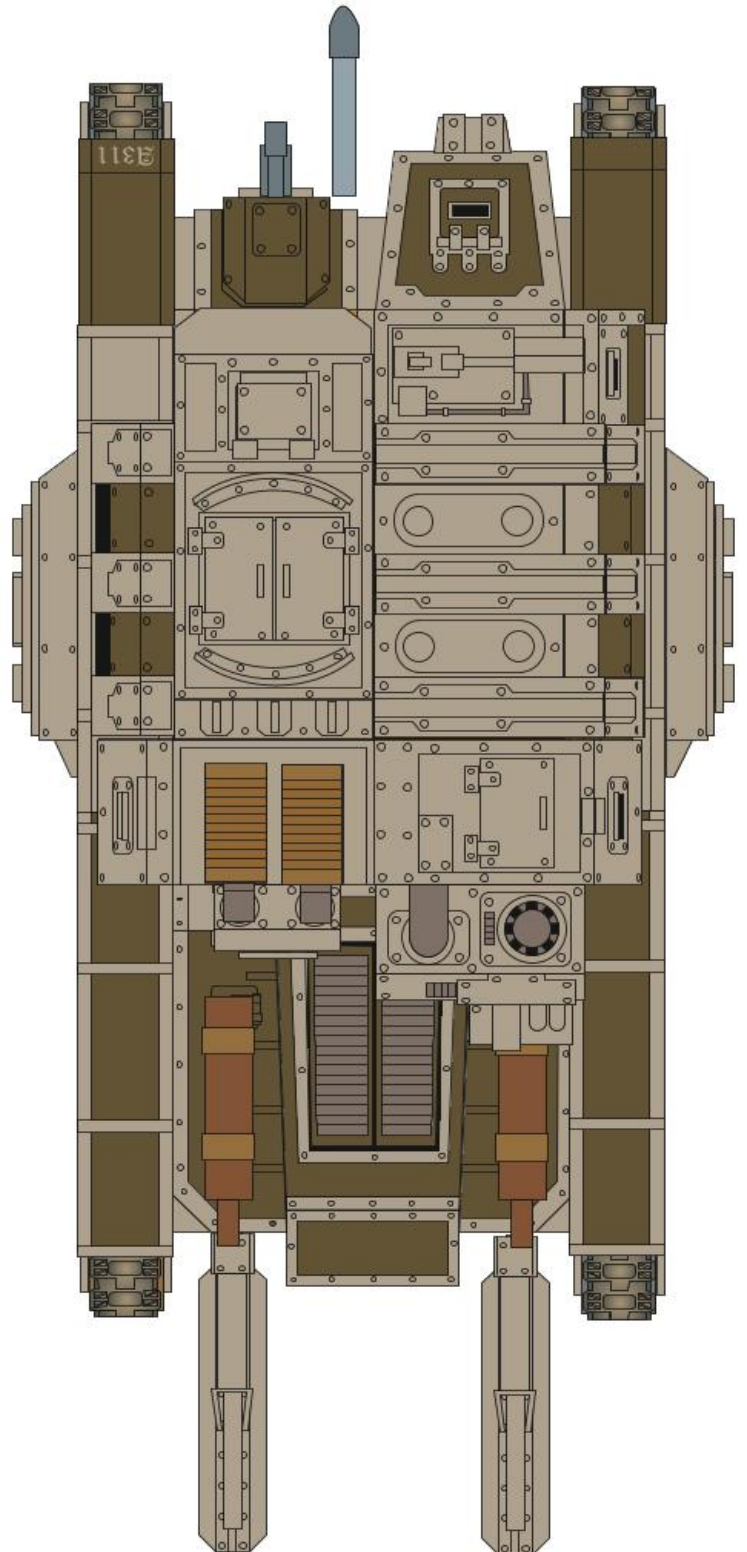
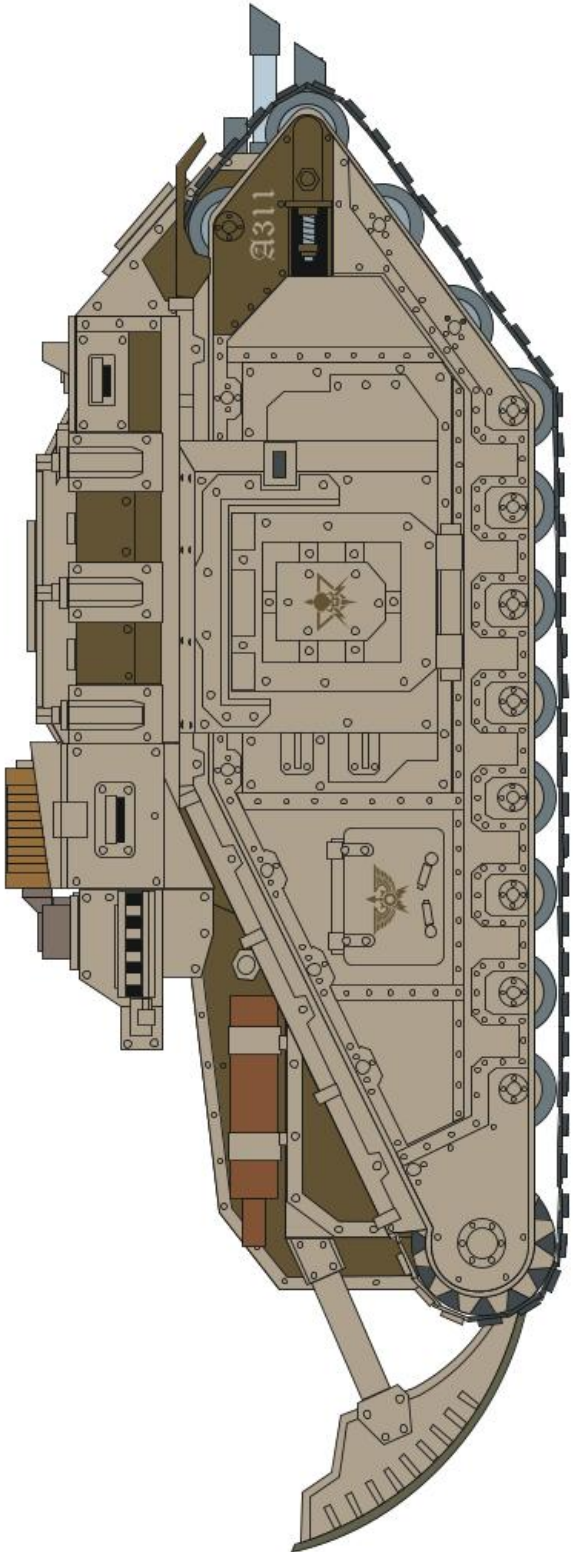

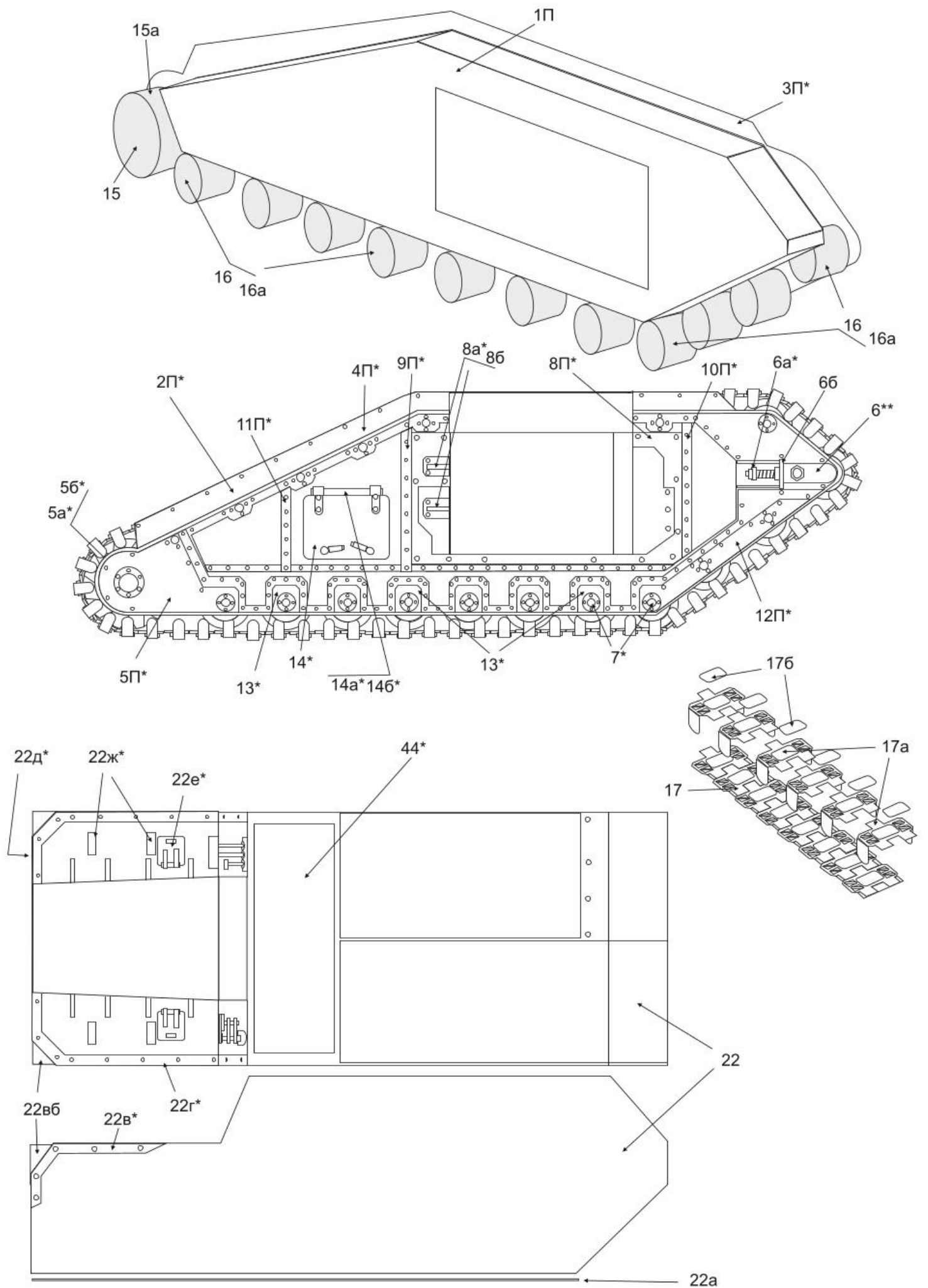

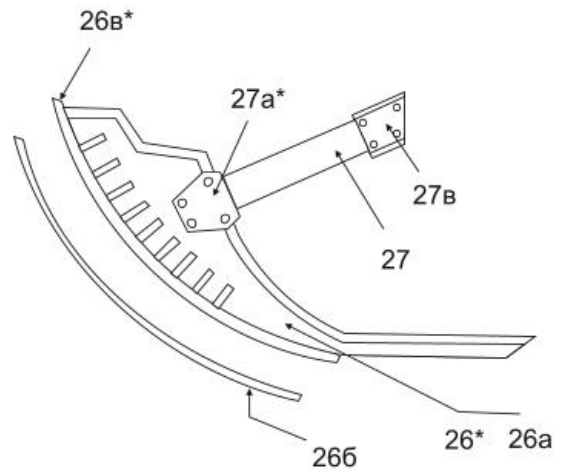
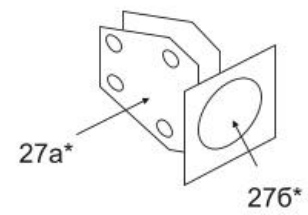
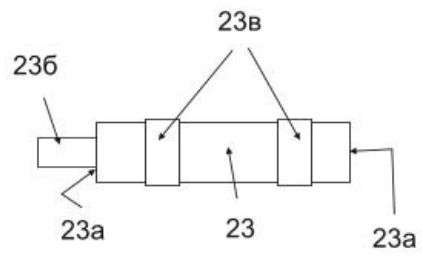
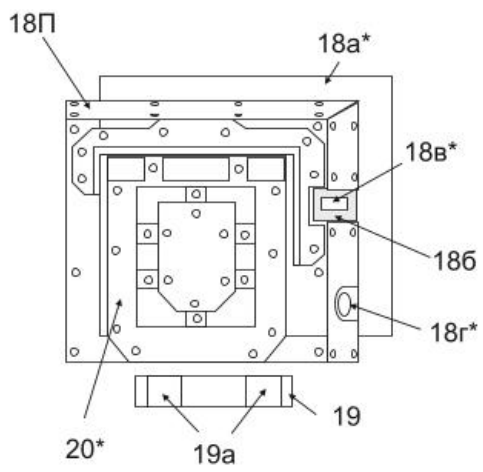
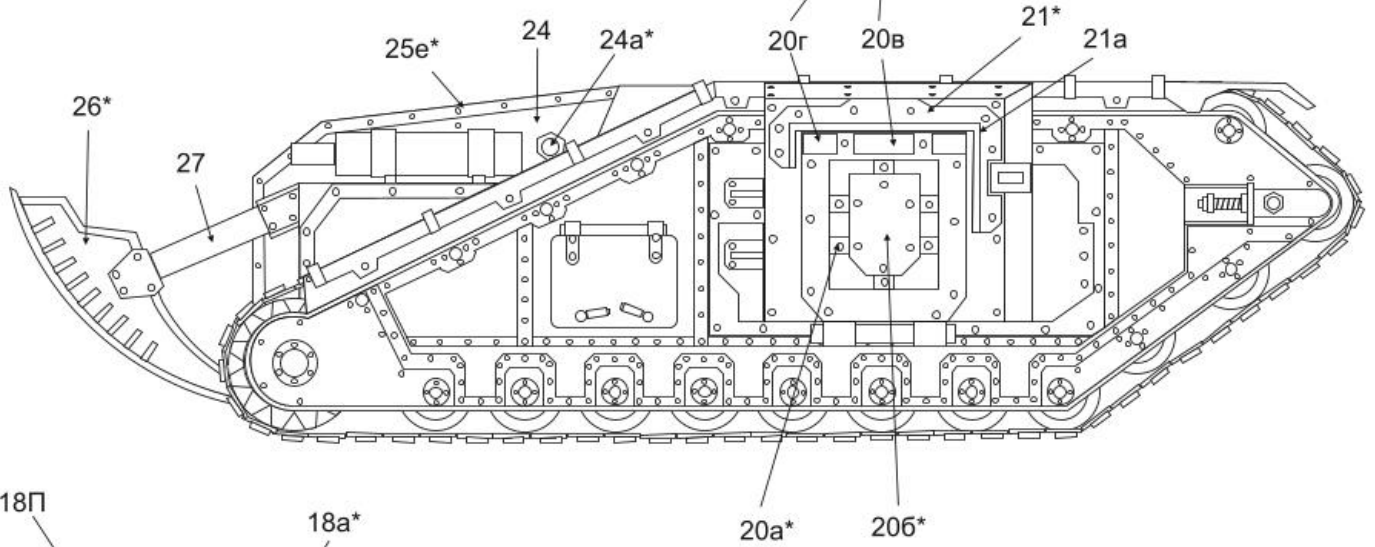
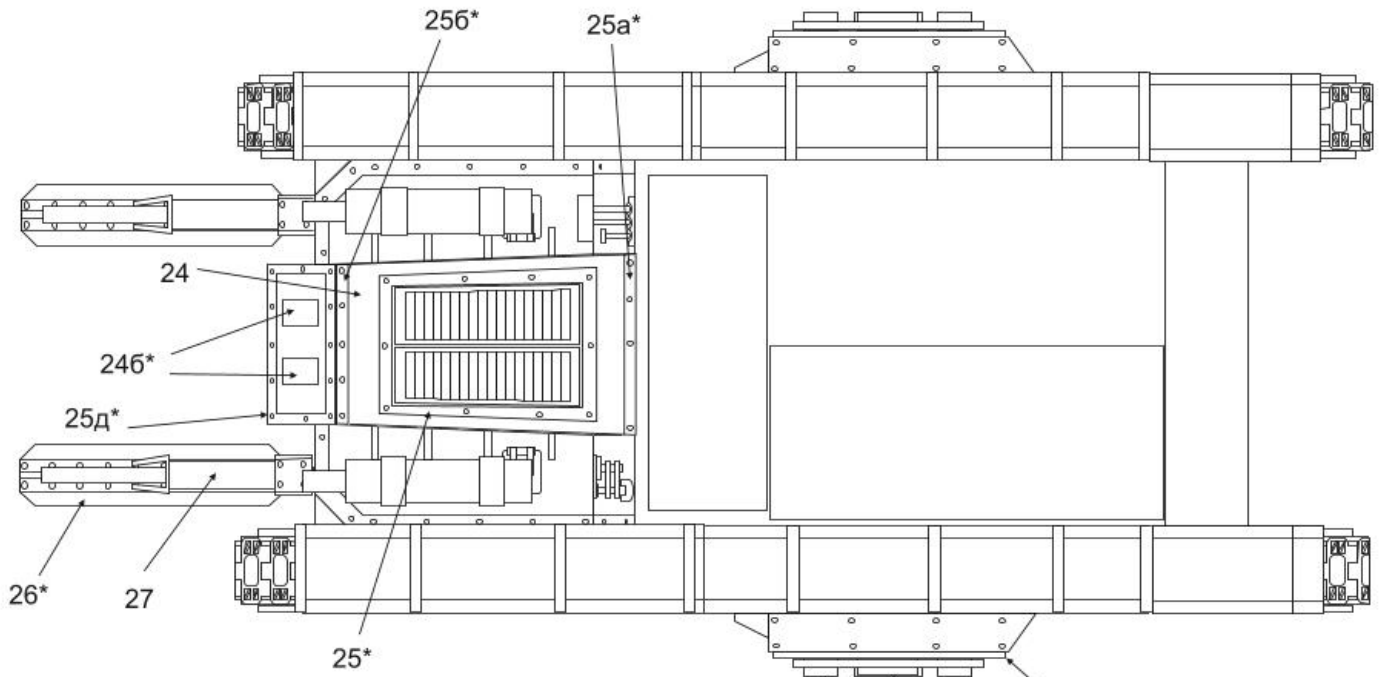

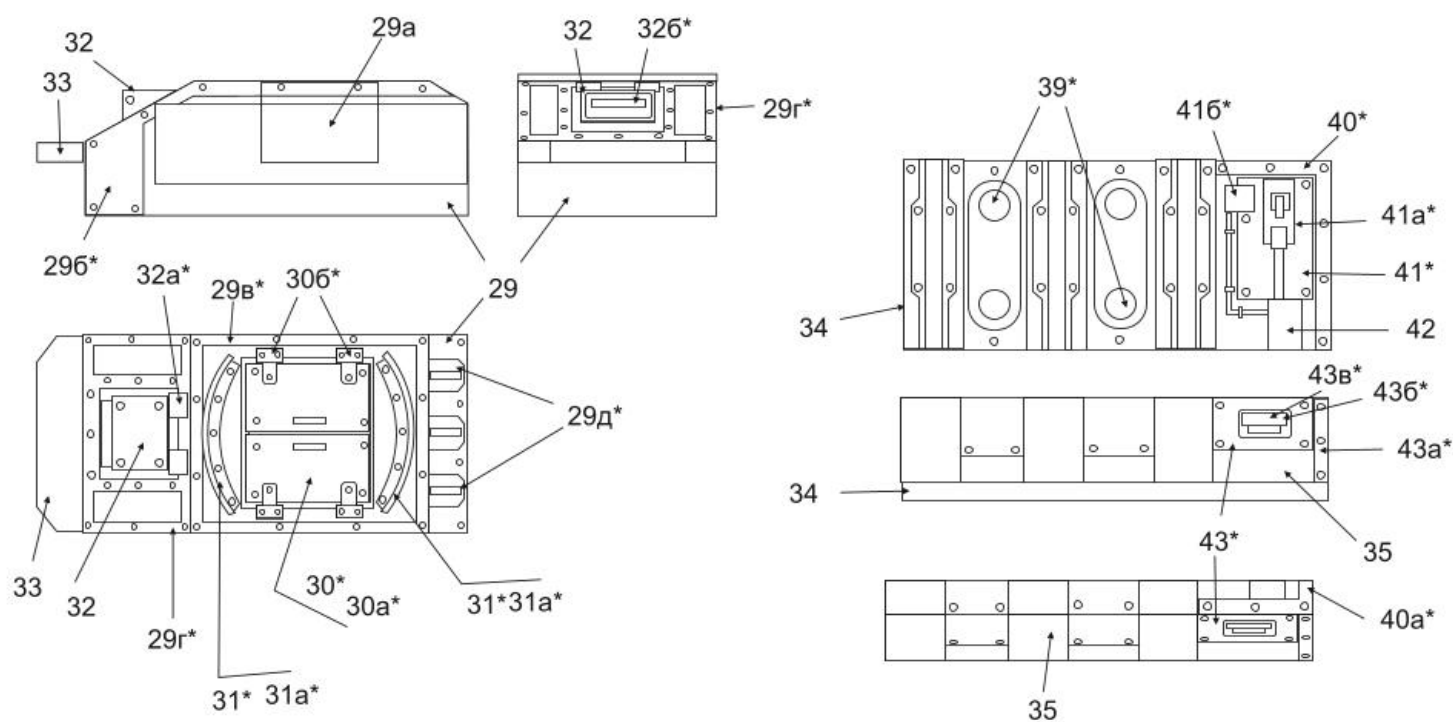
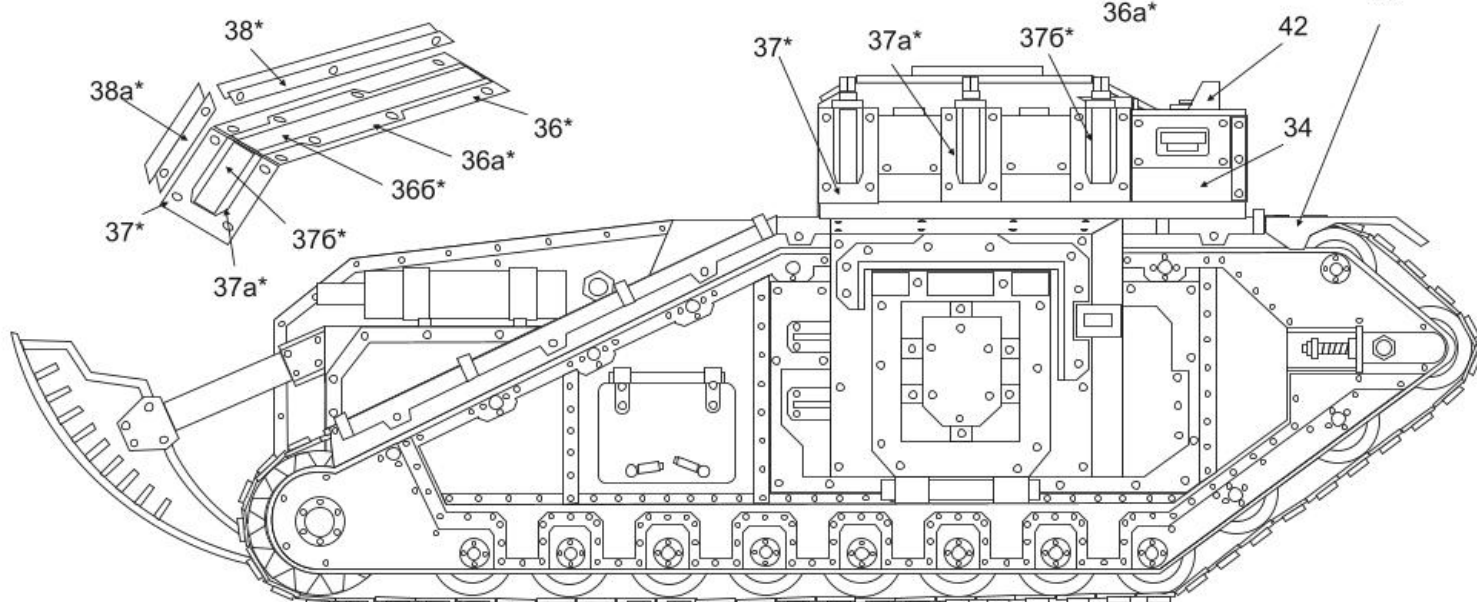
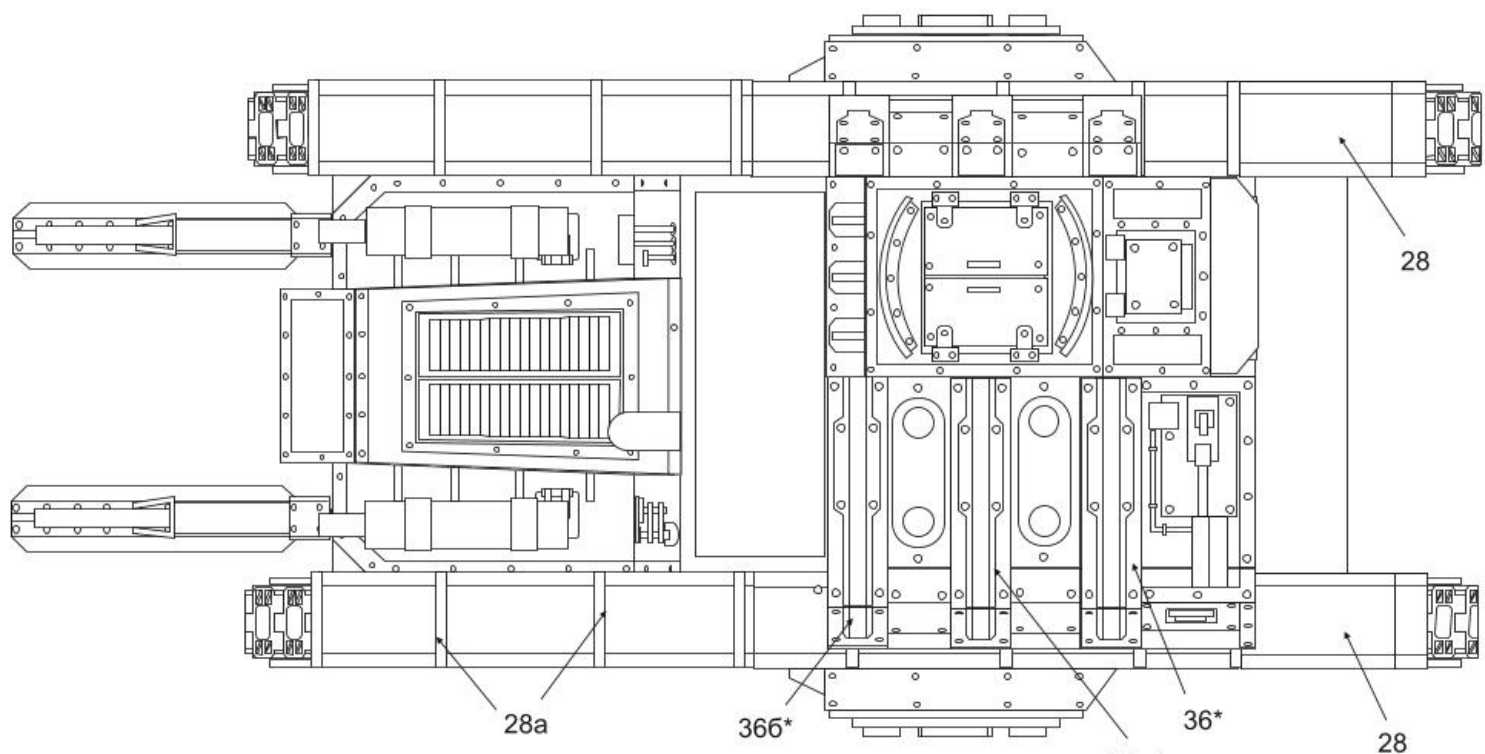

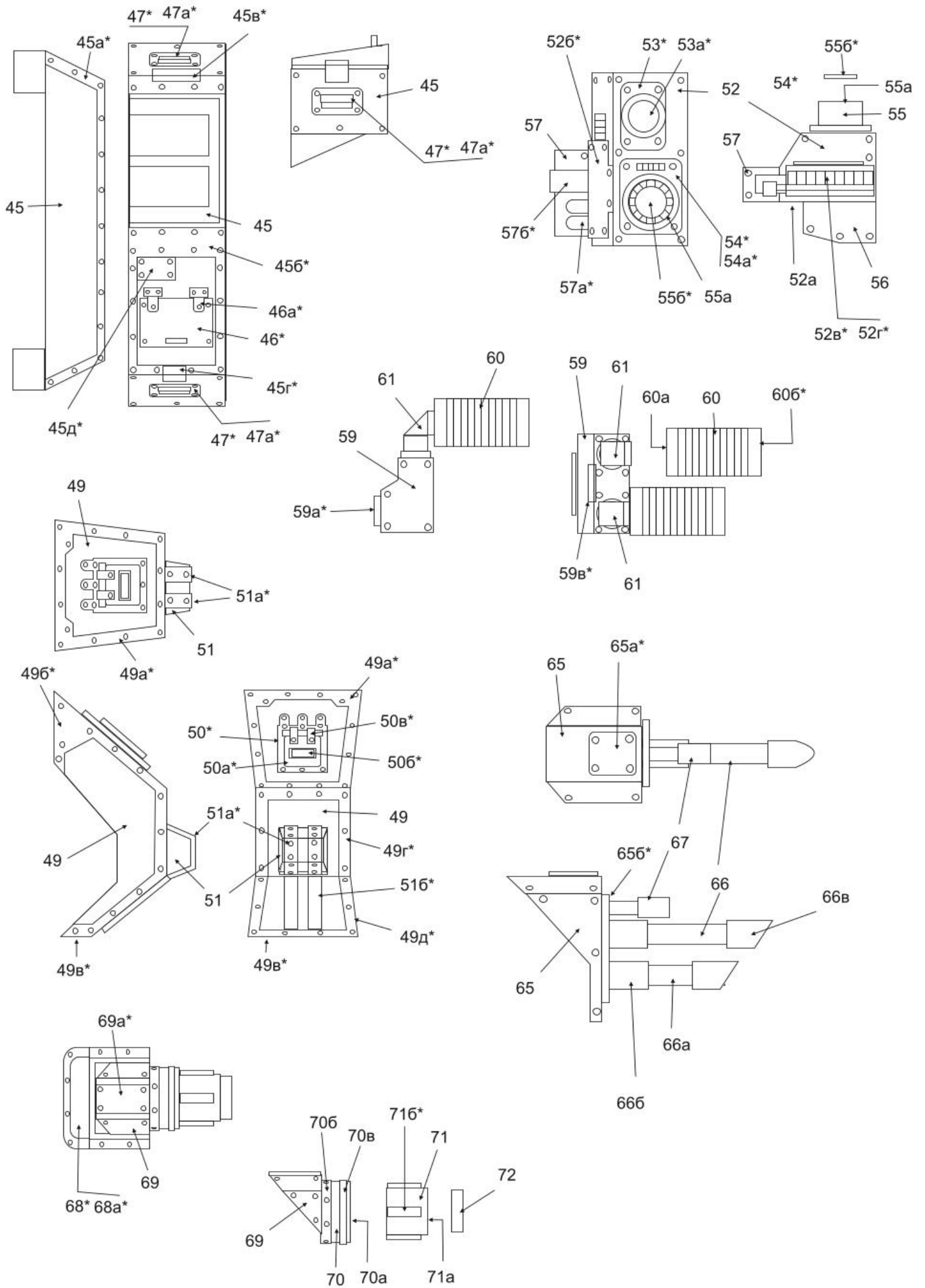

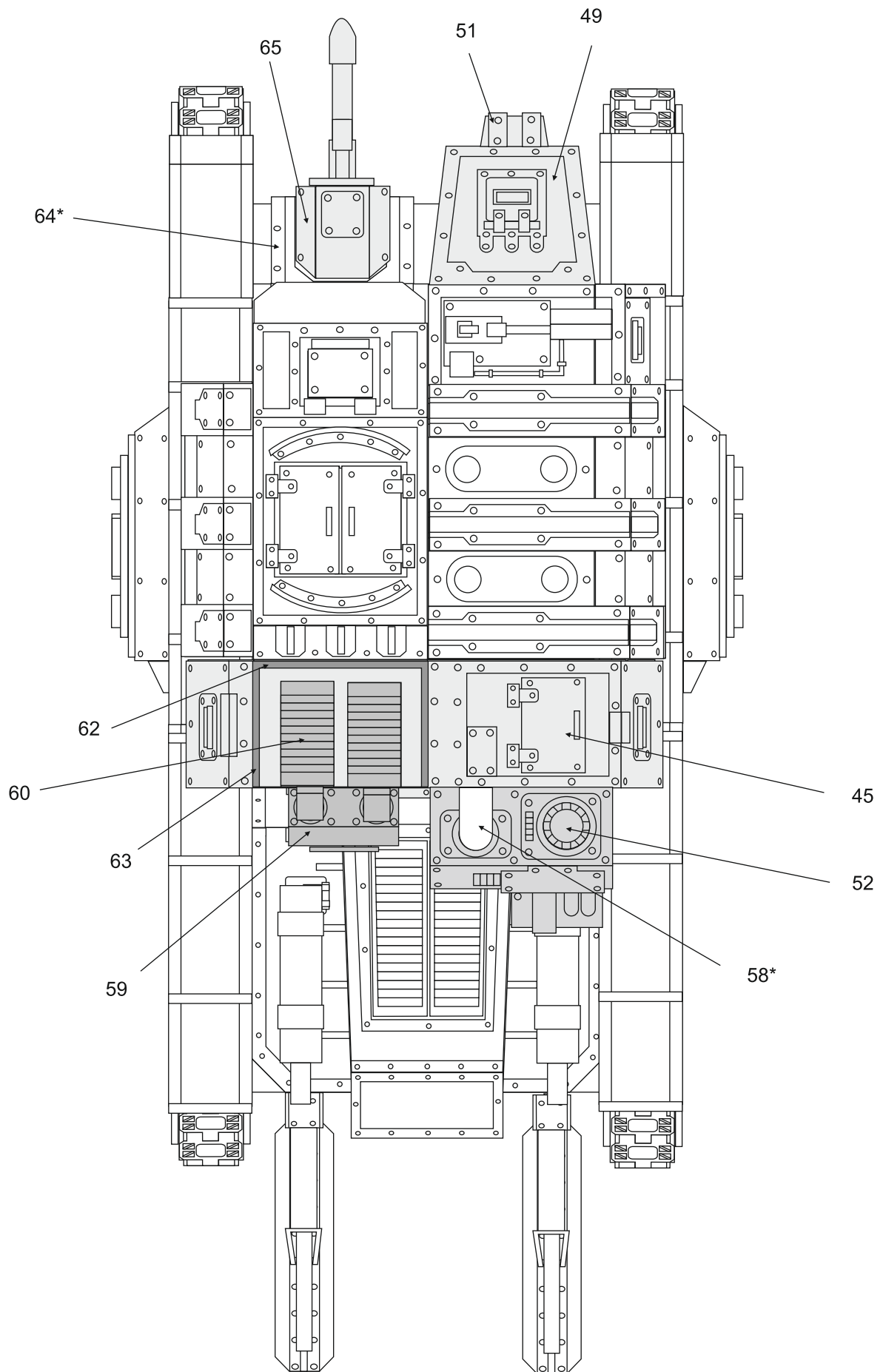

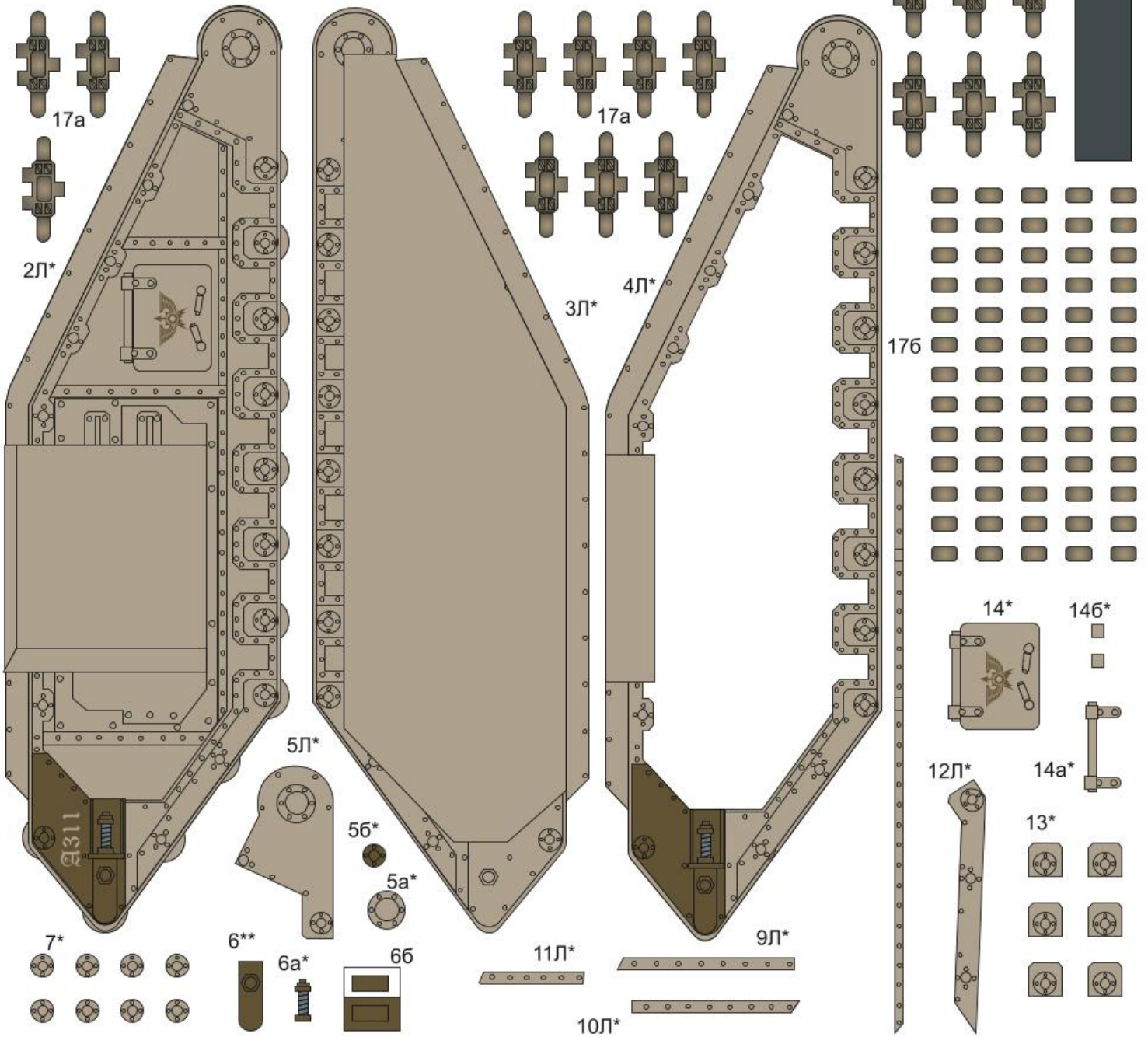
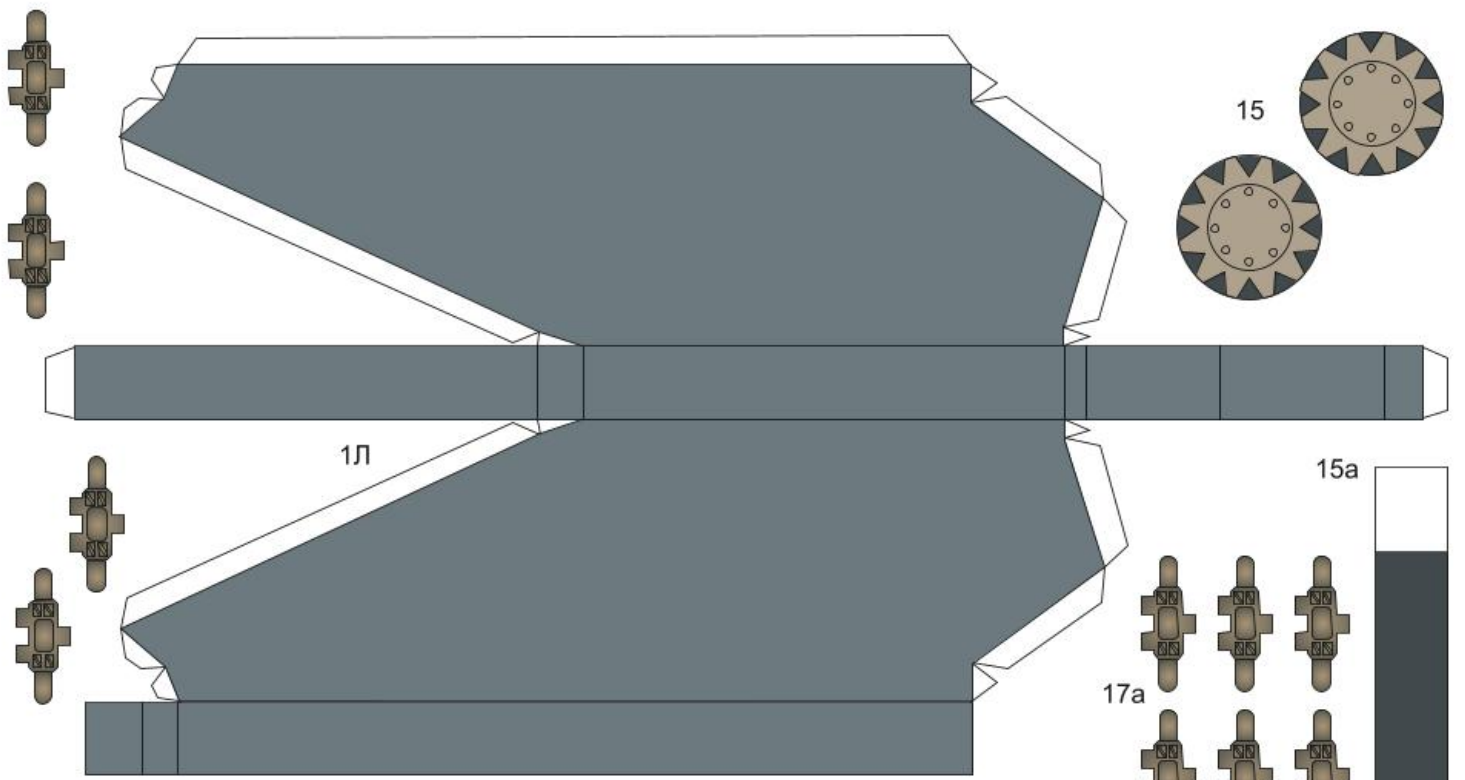

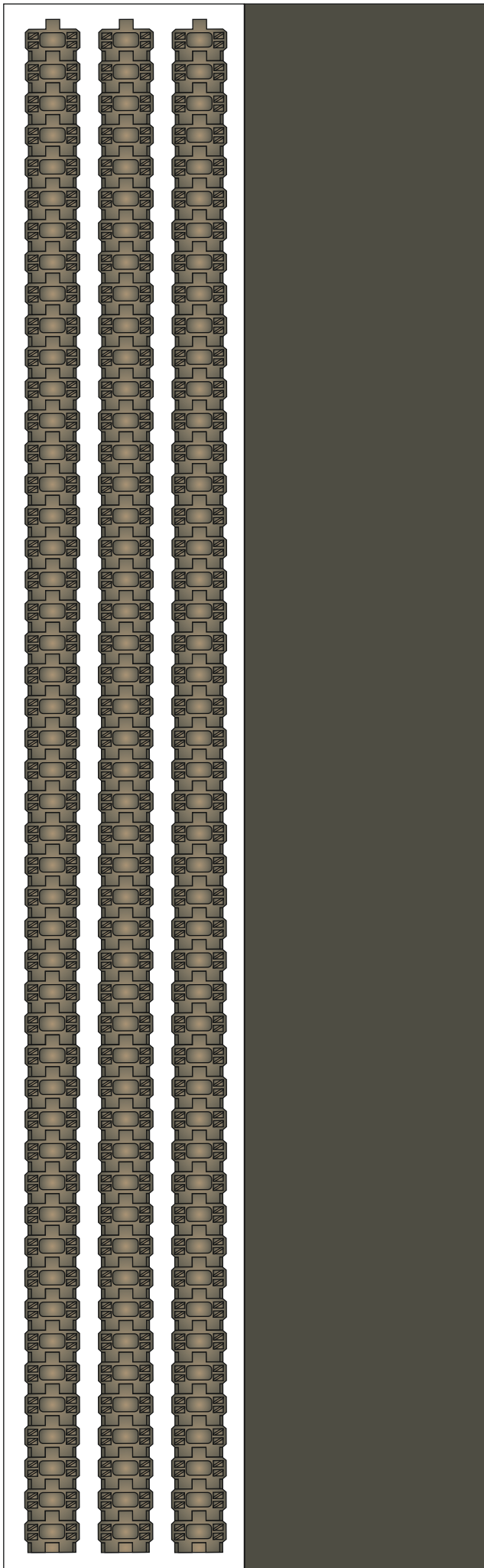

17

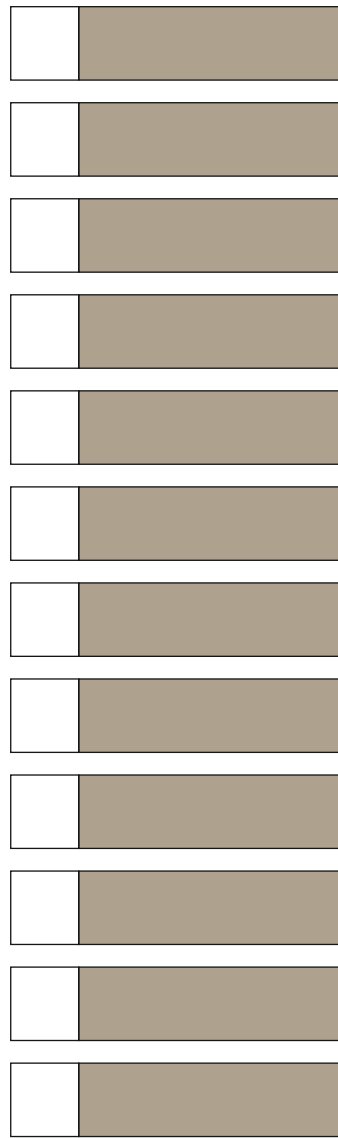

16a

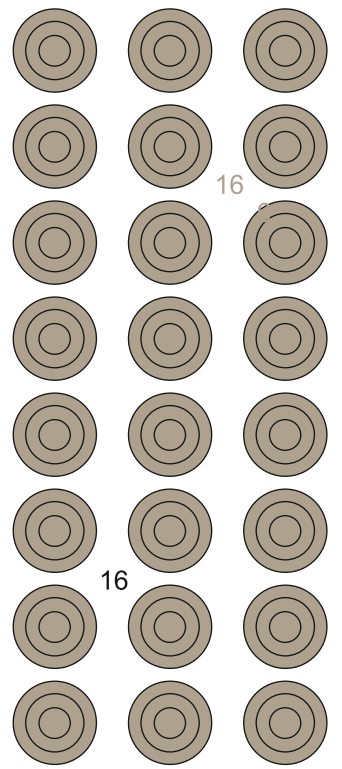

16

16

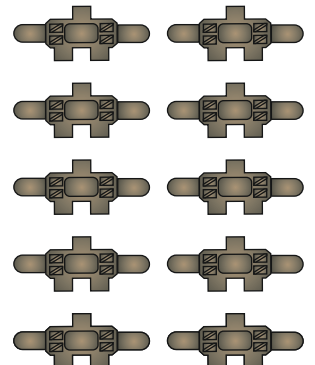

17a

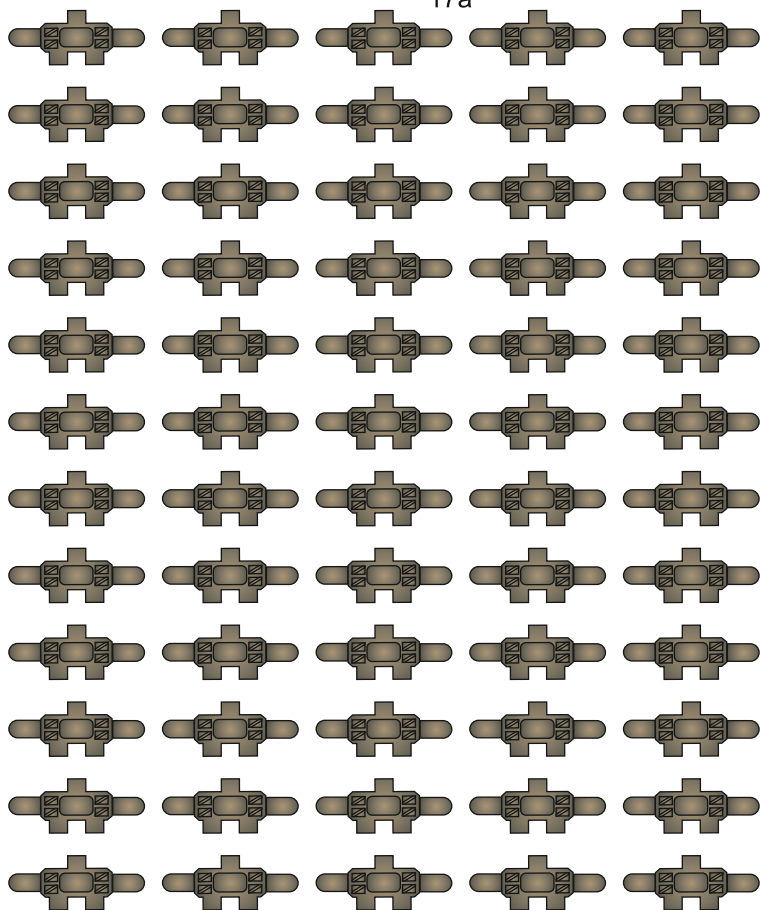

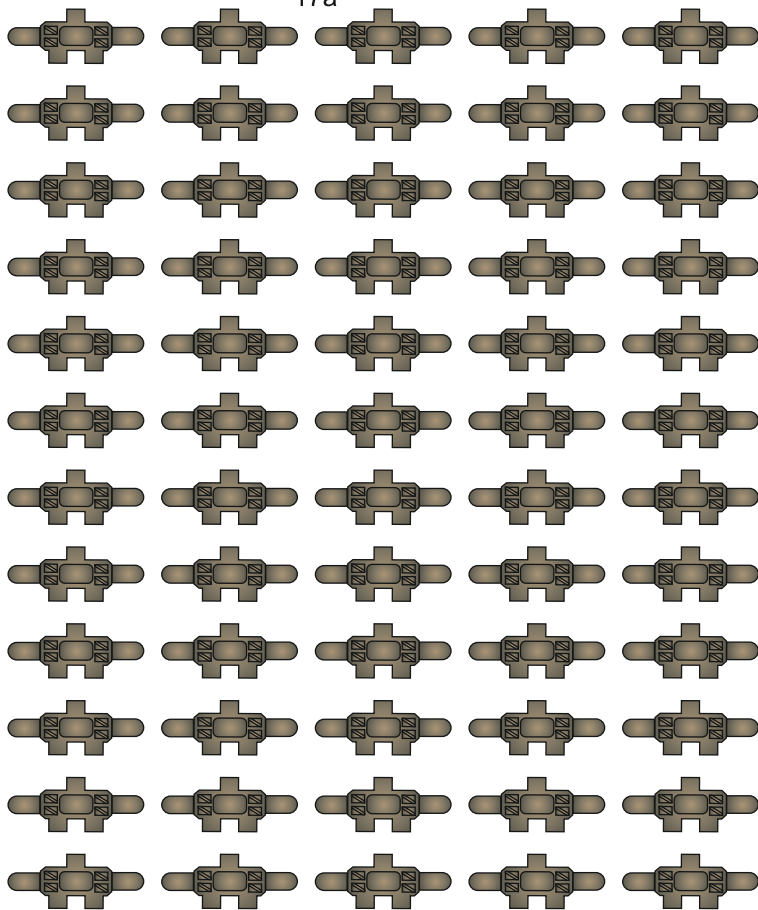
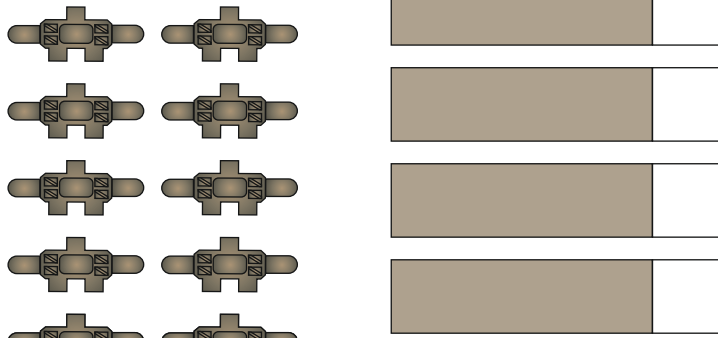
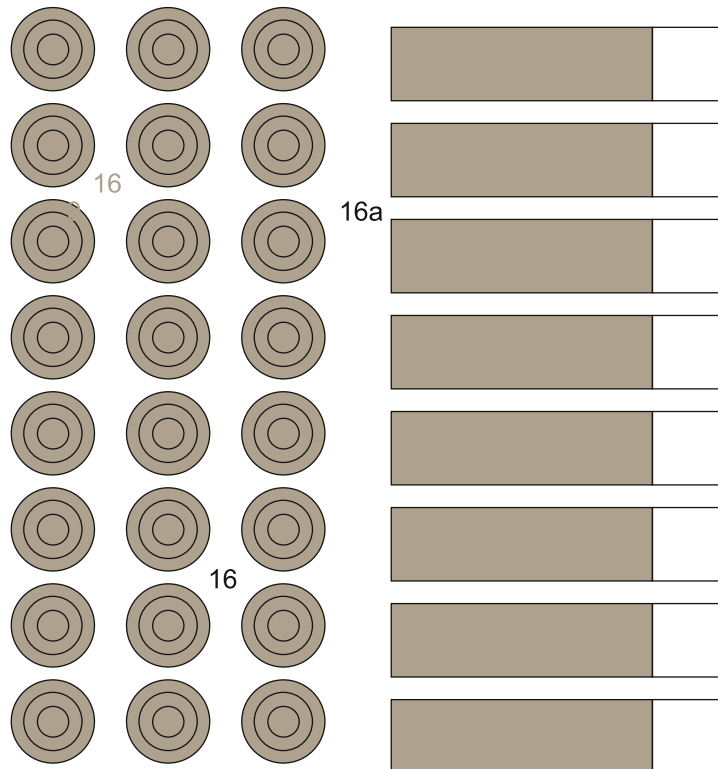

17

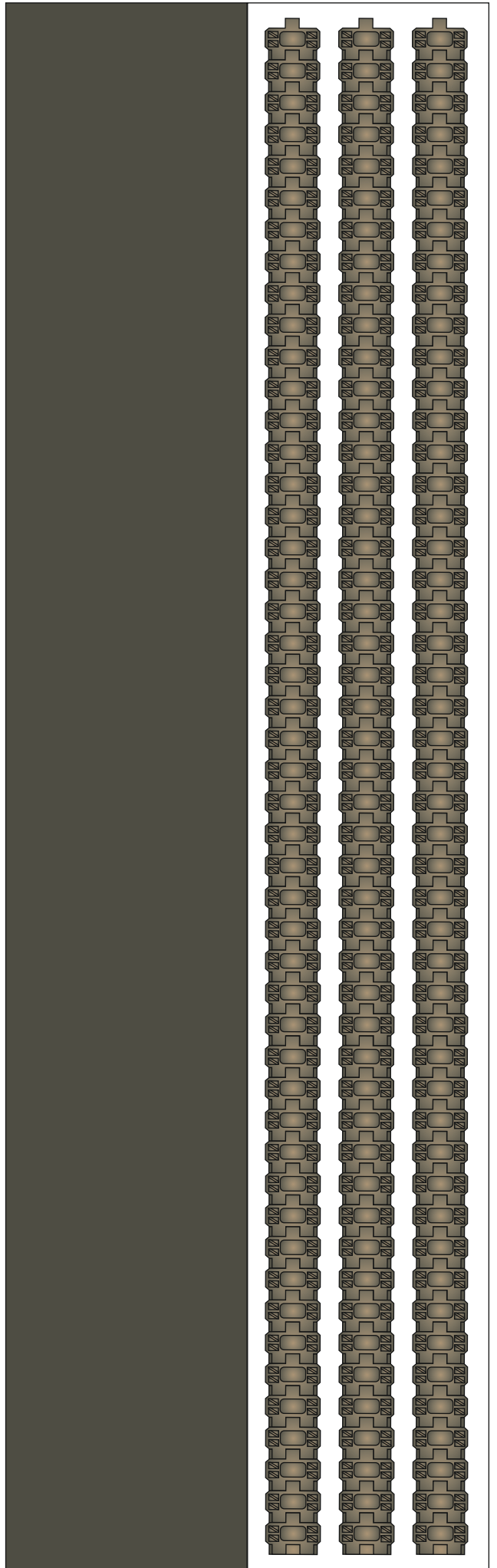

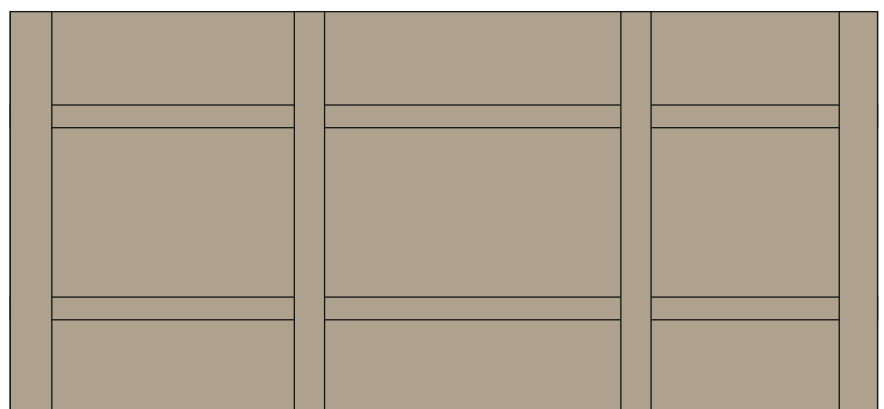
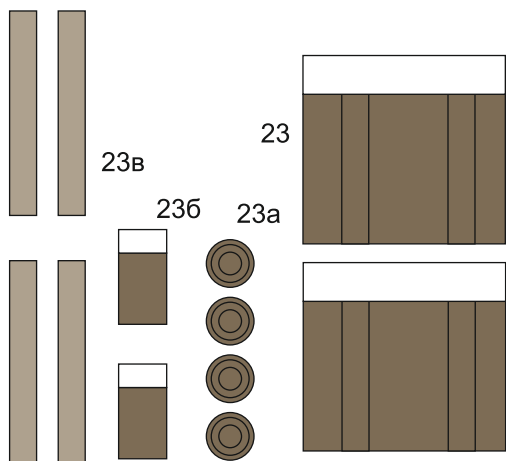
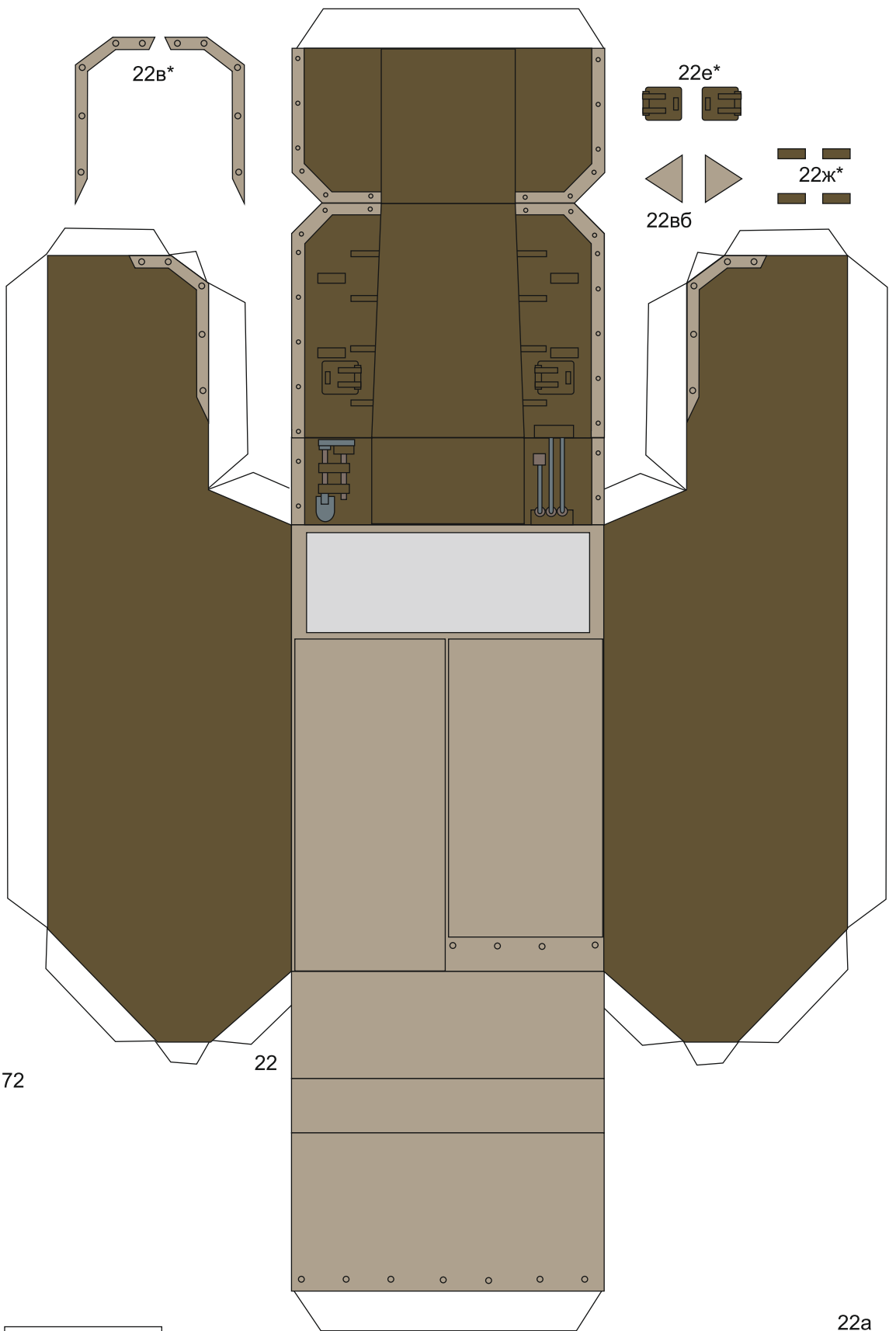
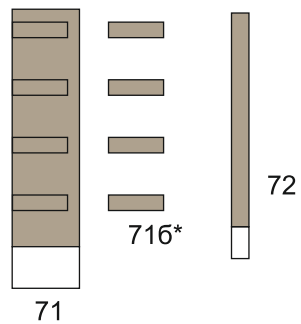
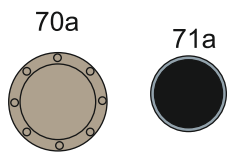
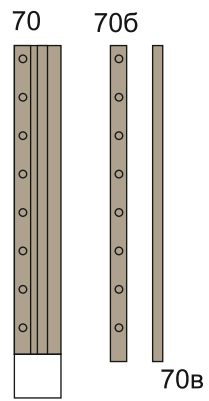
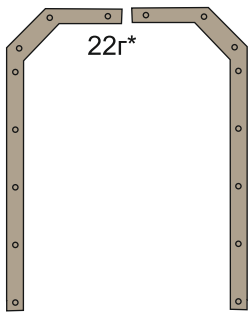
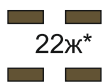
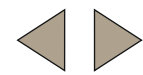
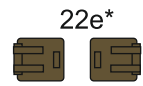
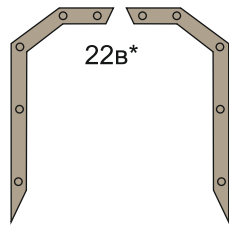
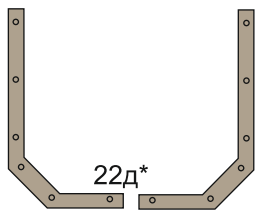

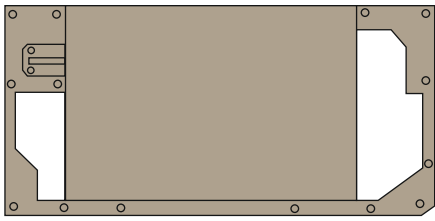

8П*

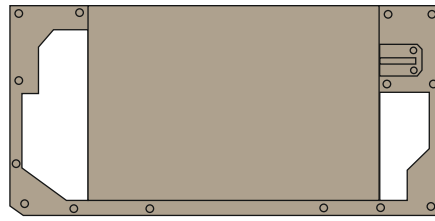

8Л*

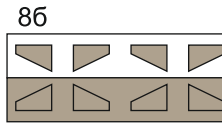
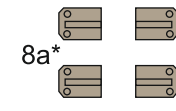

8б

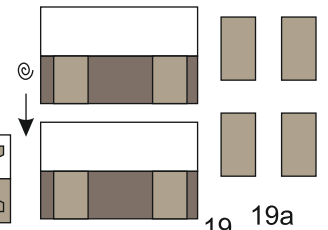

19 19a

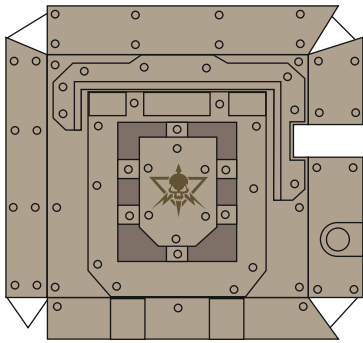

18П

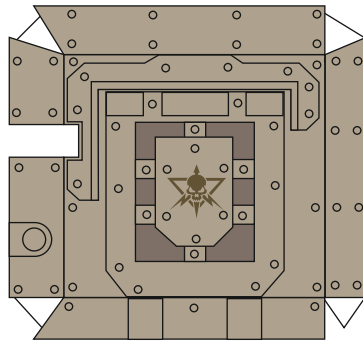

18Л

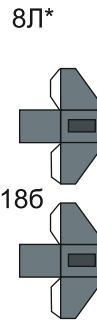

18б

18в*

18г*

20*

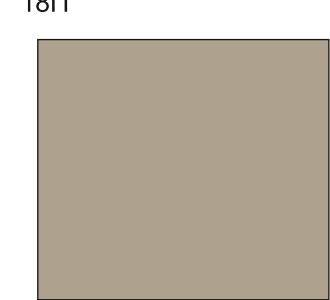
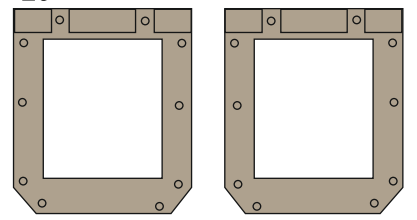

18a*

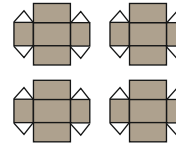

20г

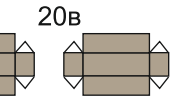
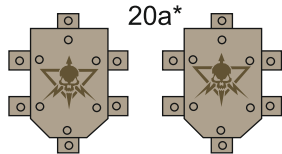

20в

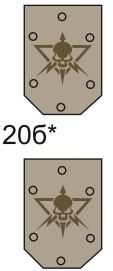

20б*

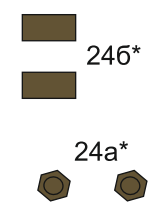

24a*

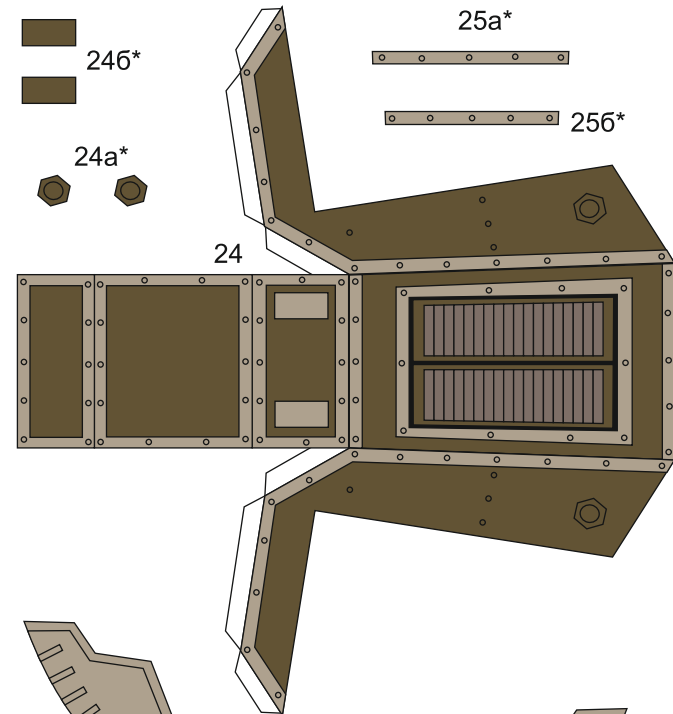

24

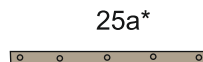

25a*



25б*

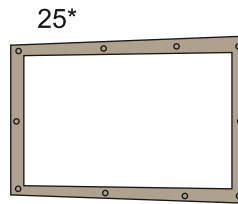

25*

21*

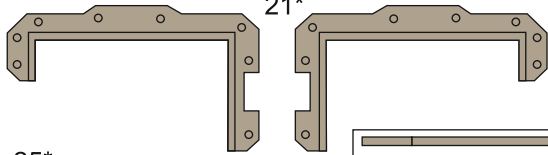

21a

25в*

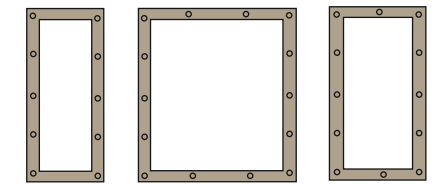

25г*

25д*

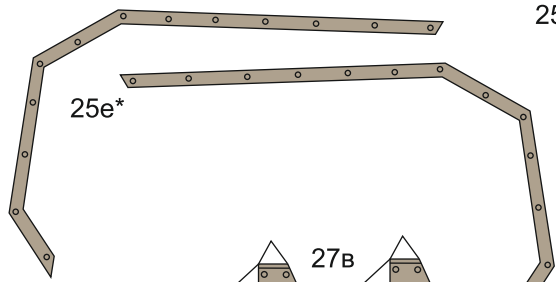

25е*

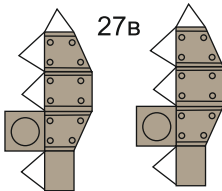

27б

27а*

27б*

27в*

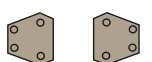
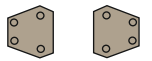

27а*

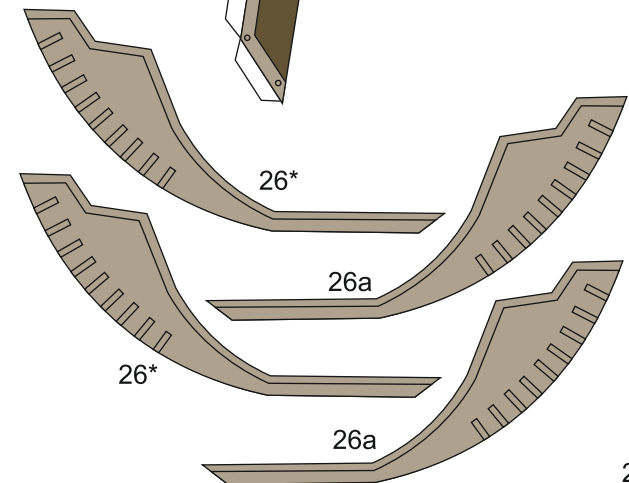

26*

26а

26*

26а

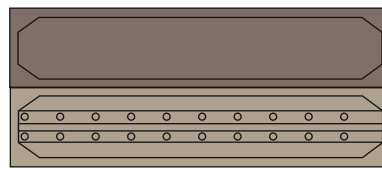

26б

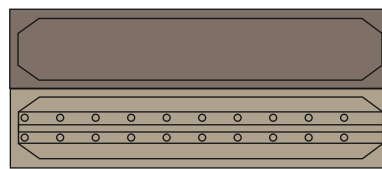

26в*



27

