

In deptus mechanicus departamento manufacturum

PATOROCH

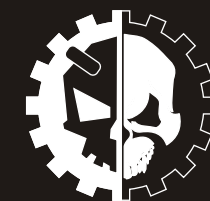

# Imperial Sector

Free model, not for sale



Made in Ukraine

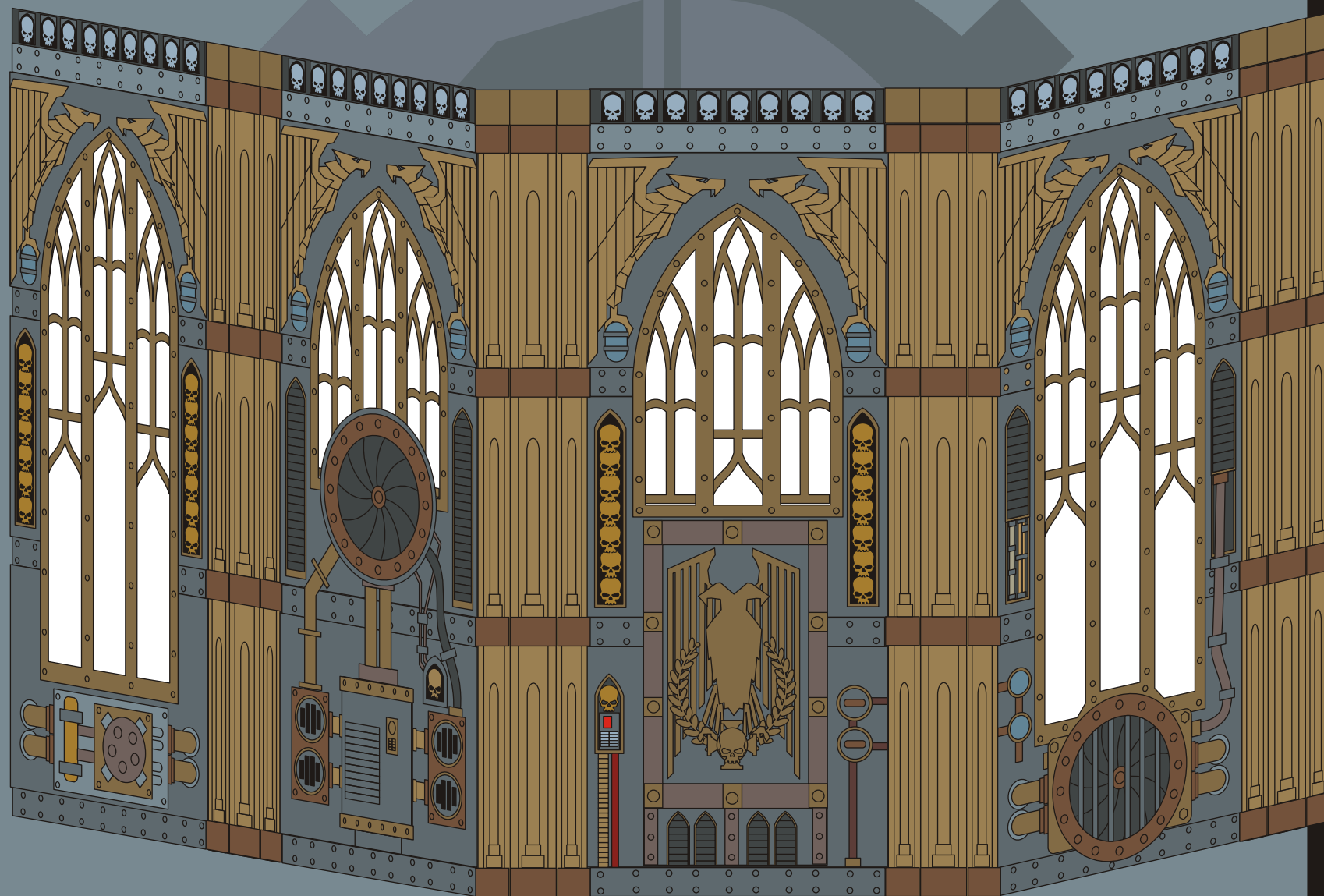

18

RUINȚA PRINȚ

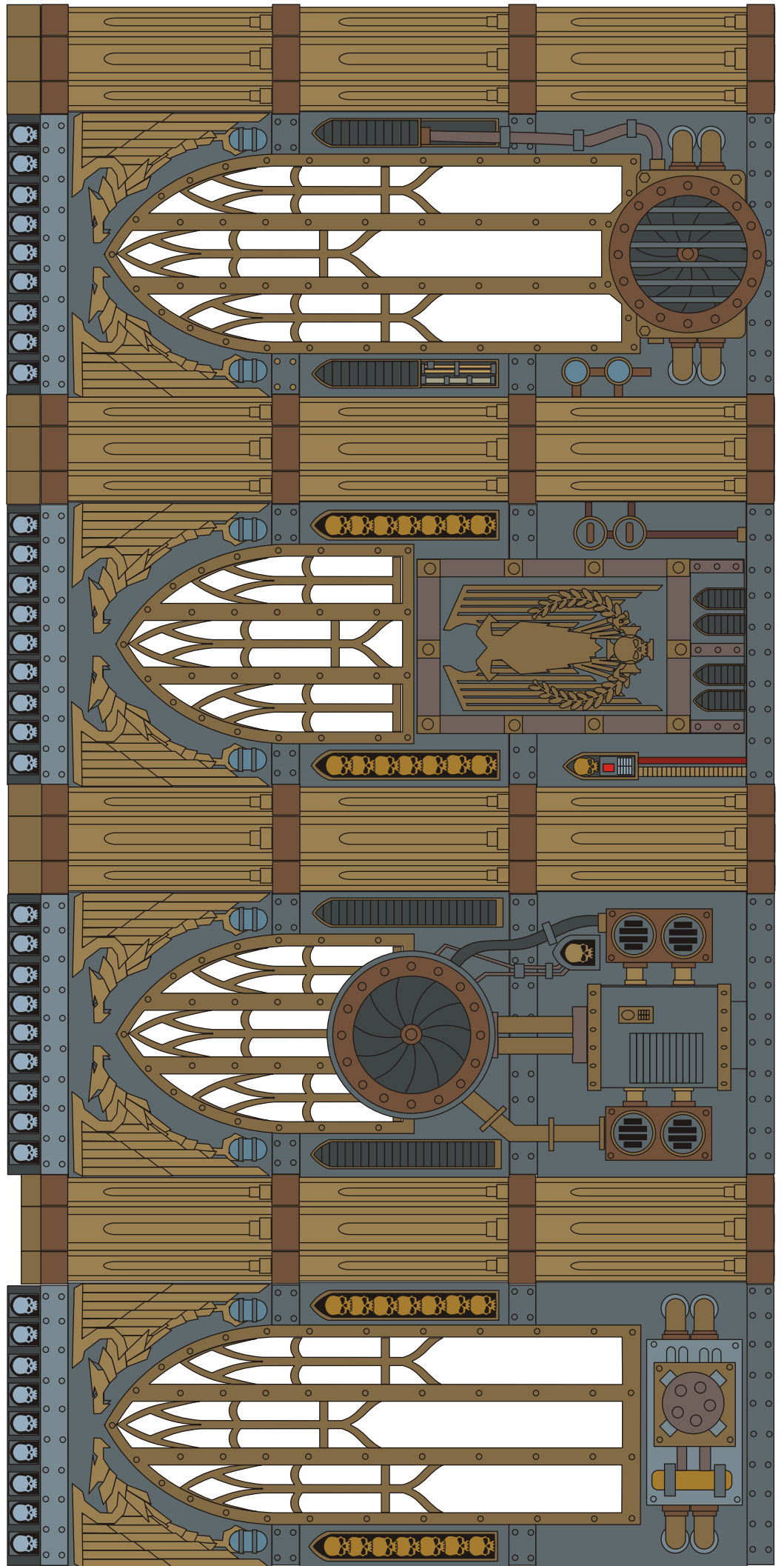
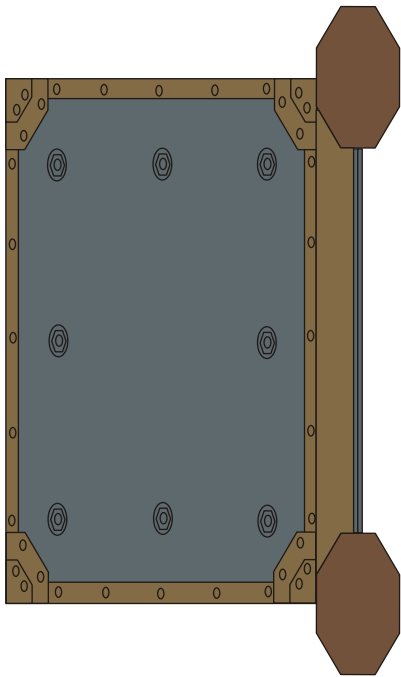

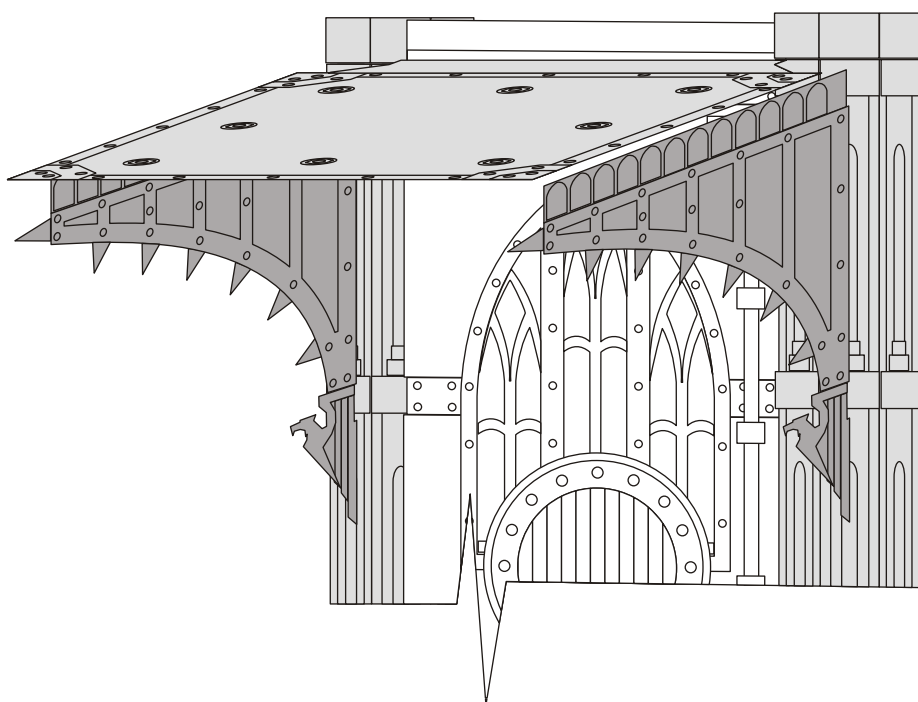
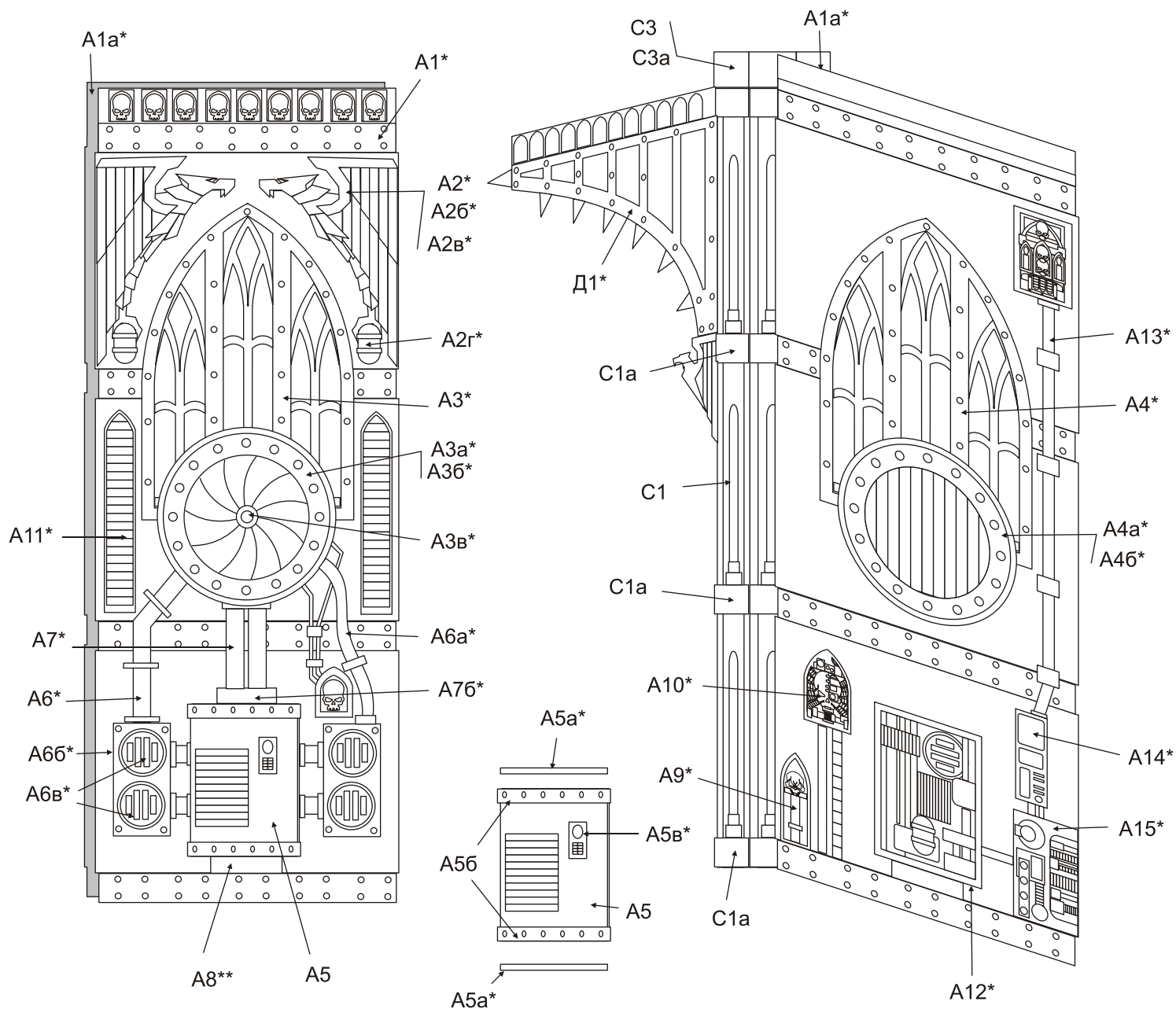

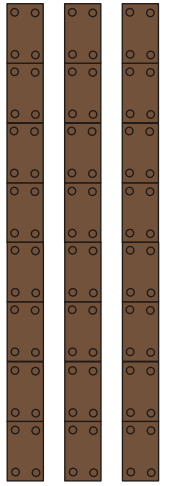
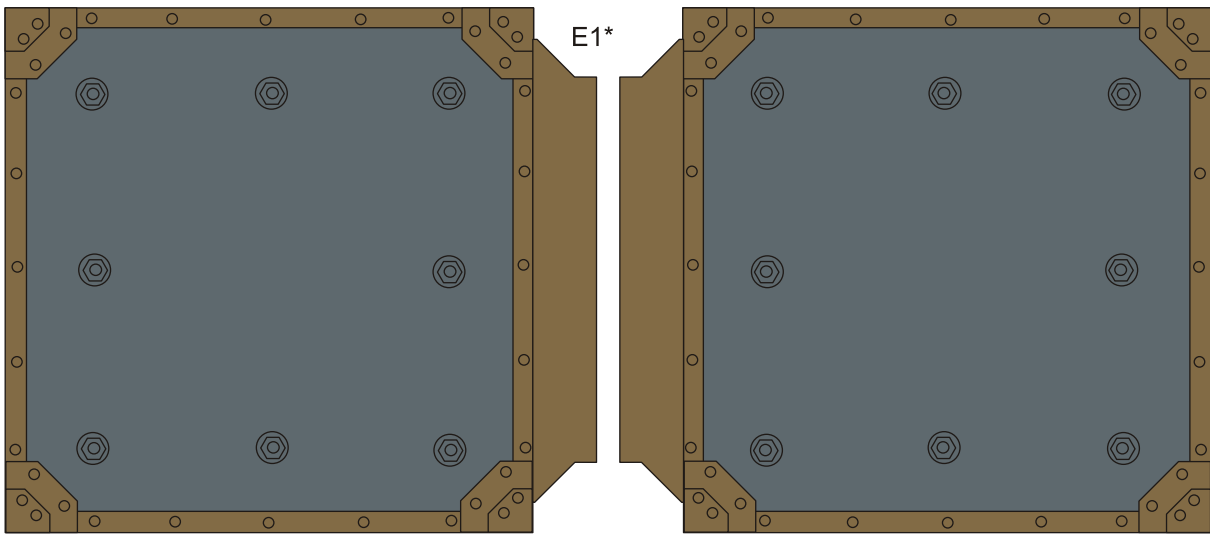
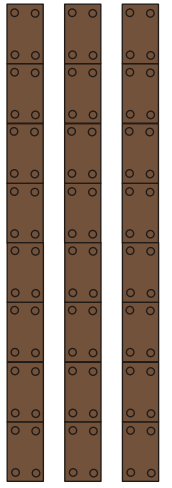
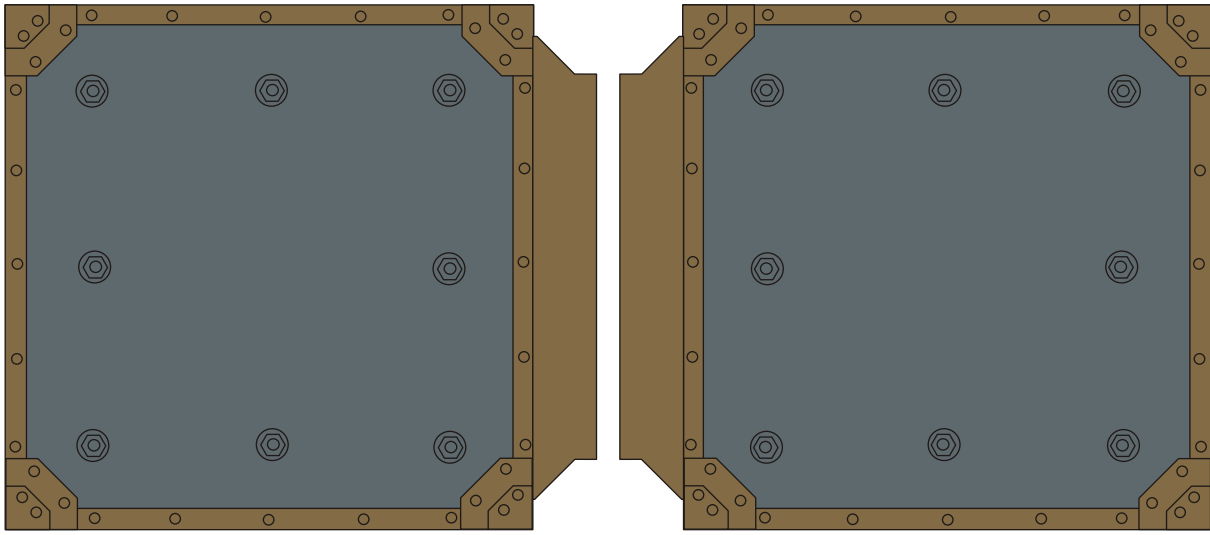

C1a

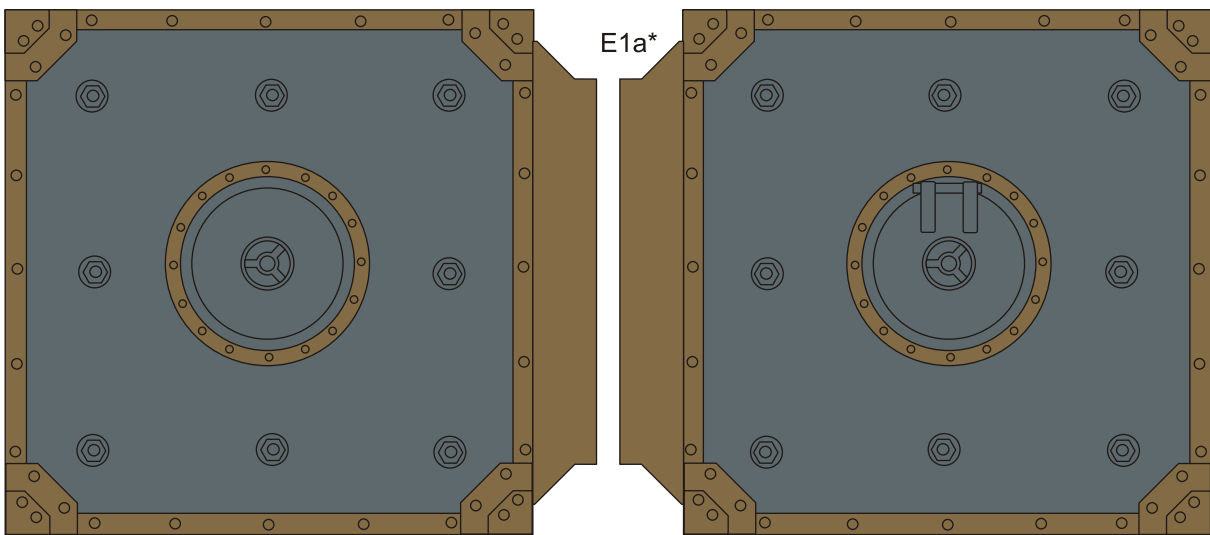

E1e\*

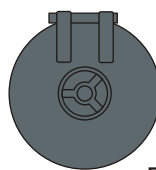

E1в\*

E1д\*



E16\*

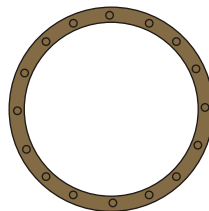

E1г\*



E1в1\*

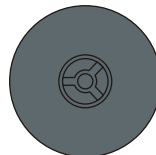

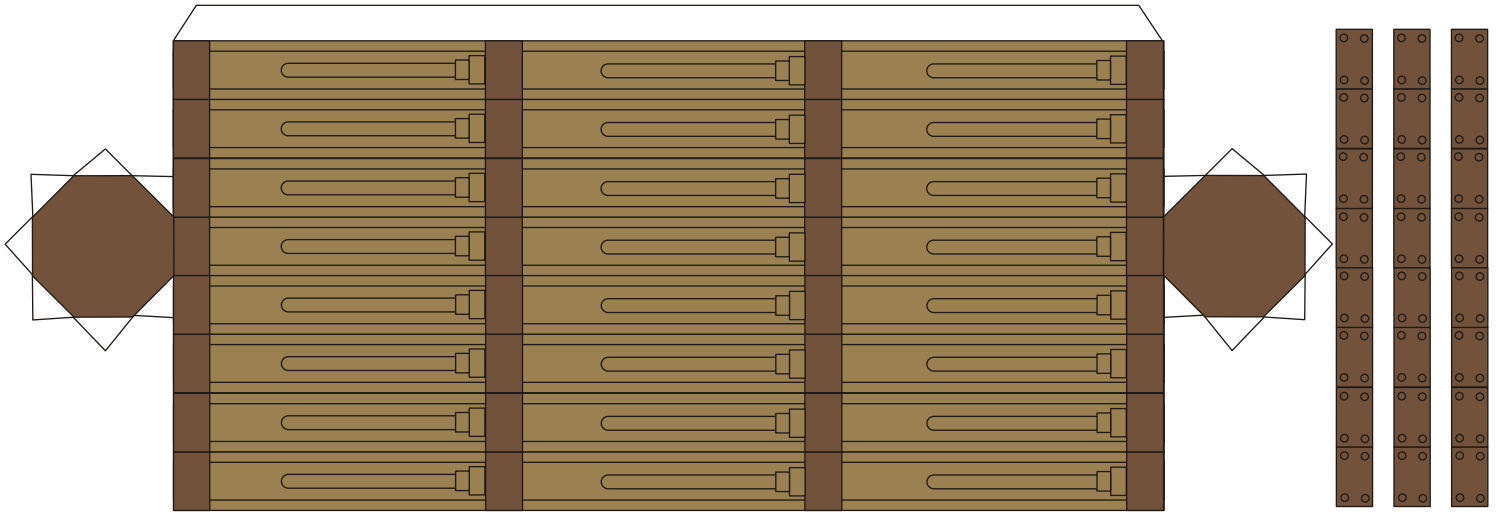

C1

C1a

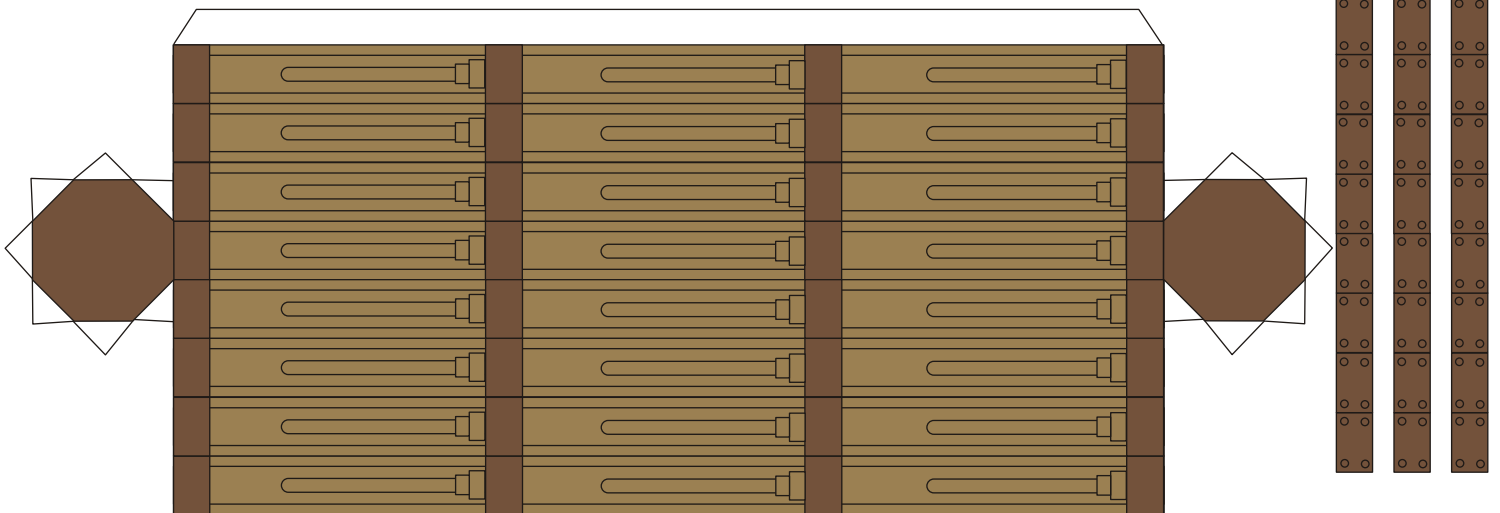
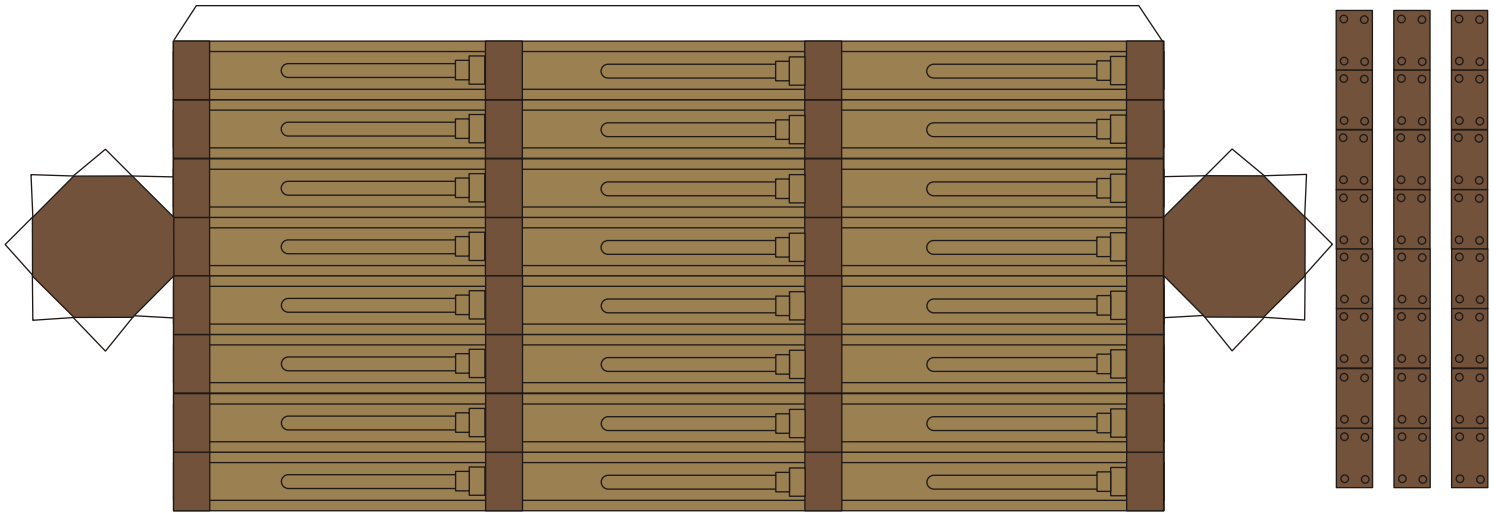
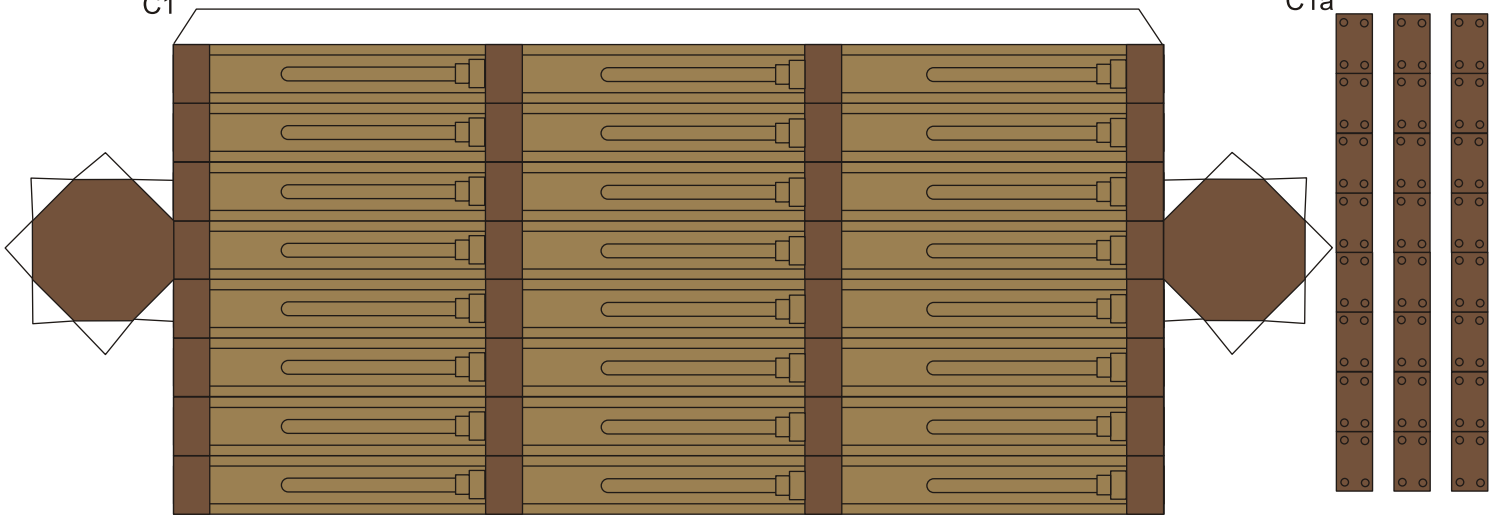

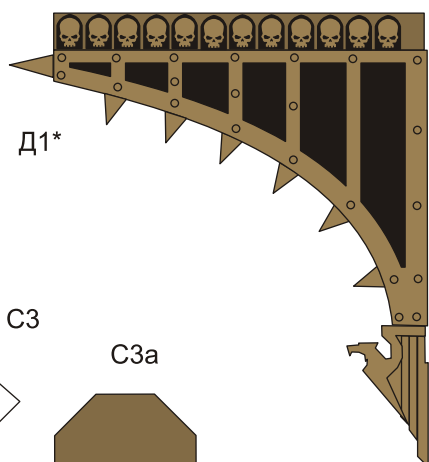
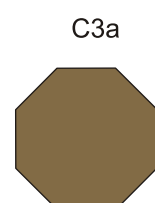
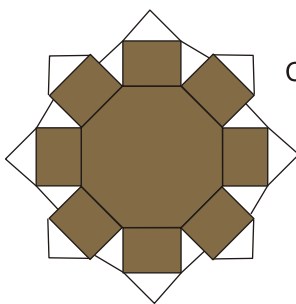
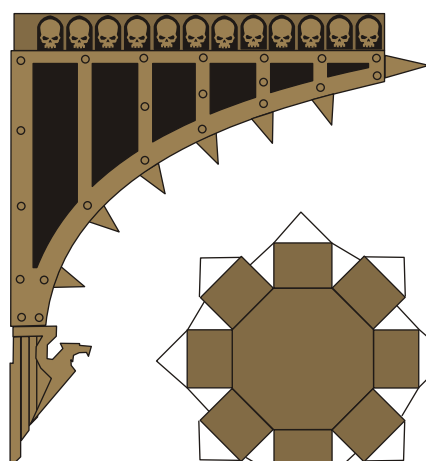
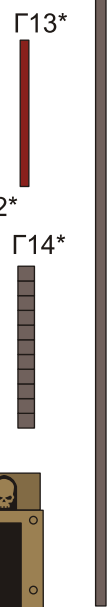
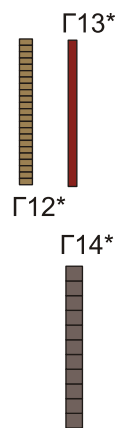
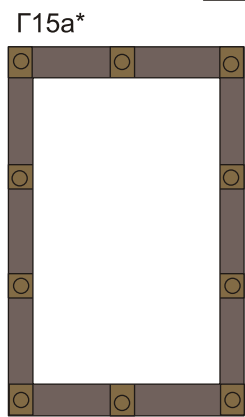
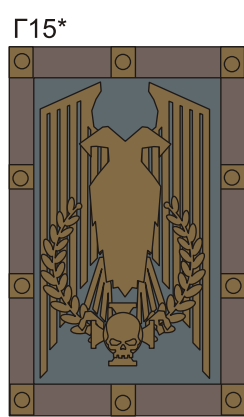
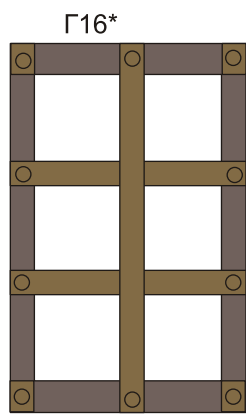
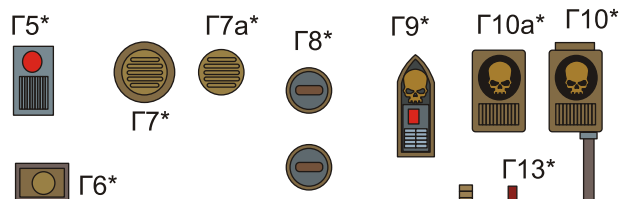
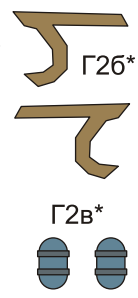
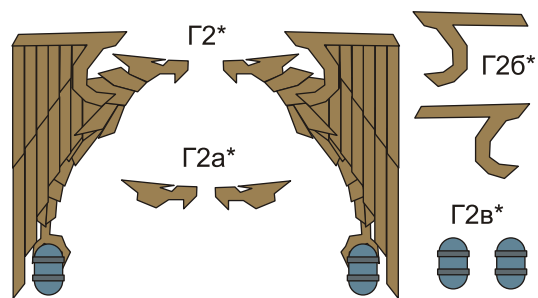
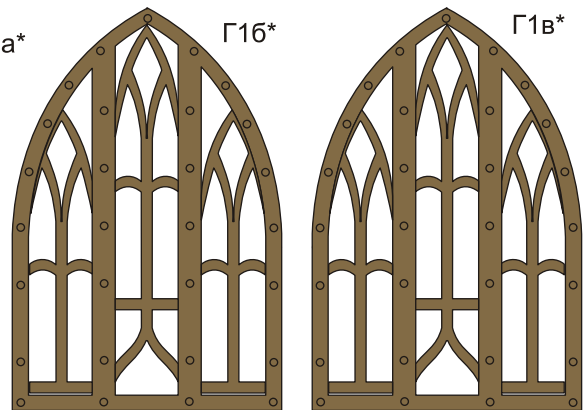
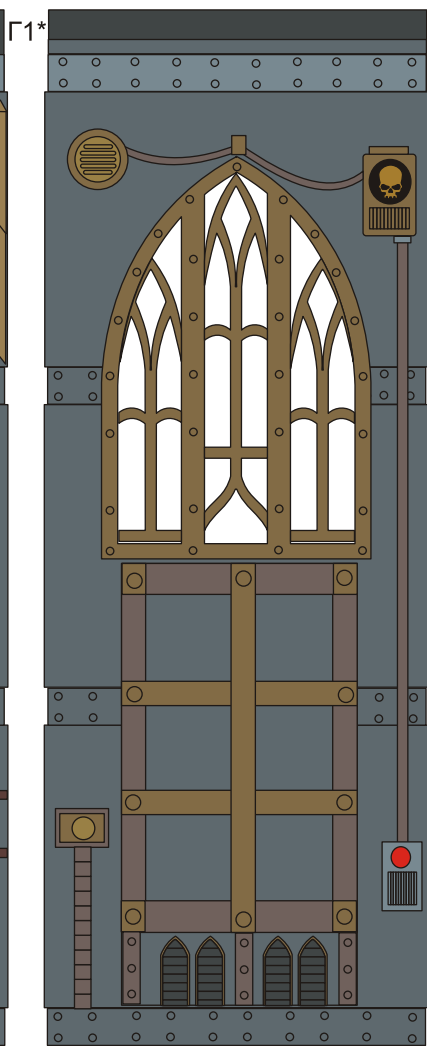
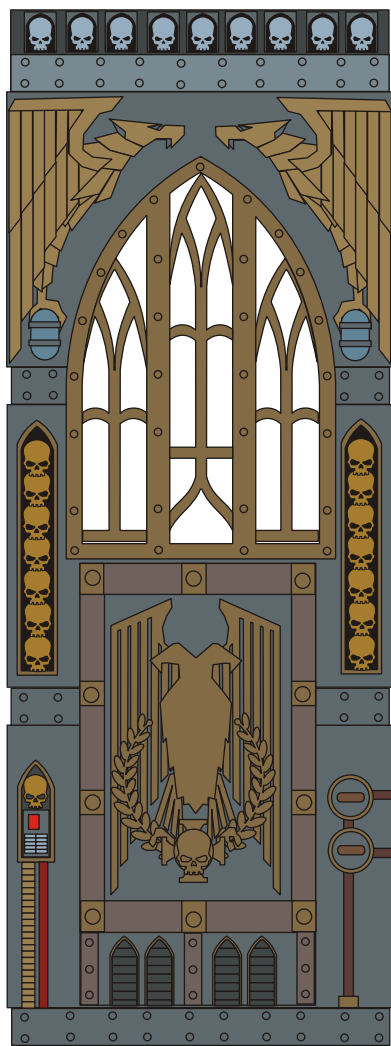

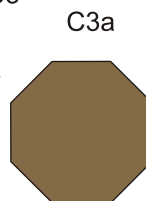
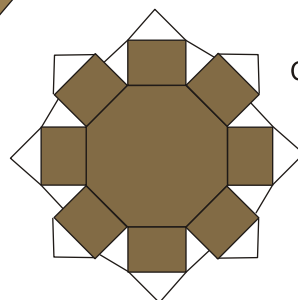
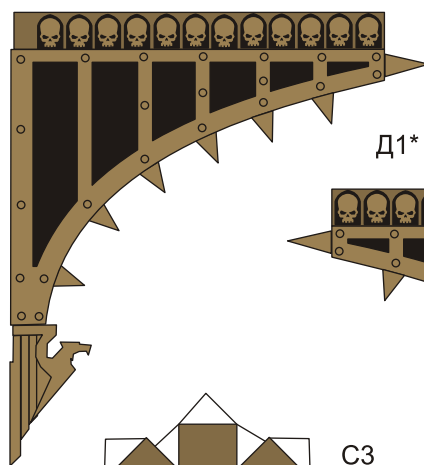
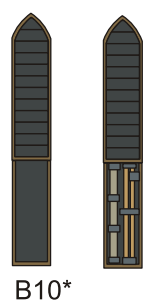
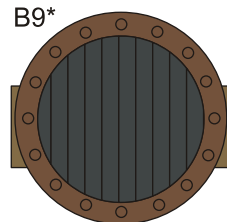
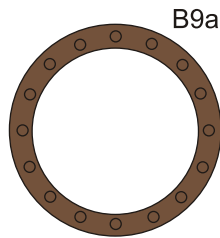
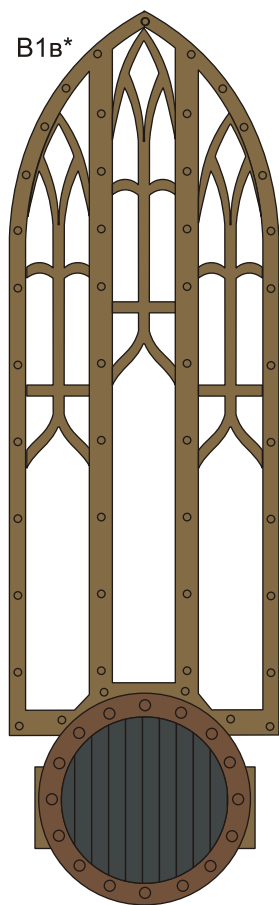
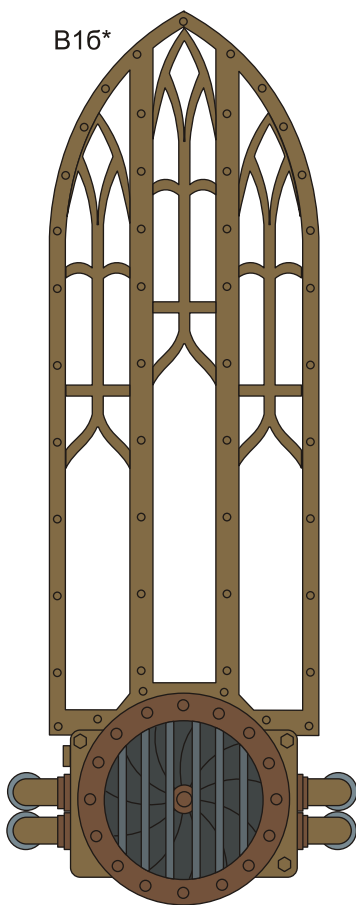
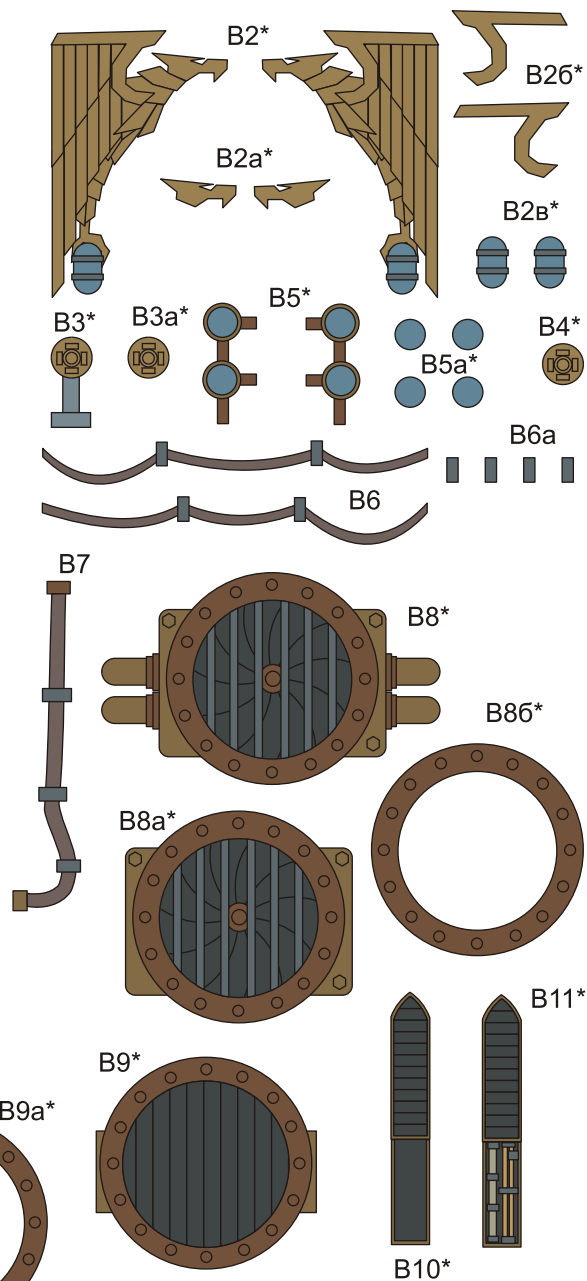
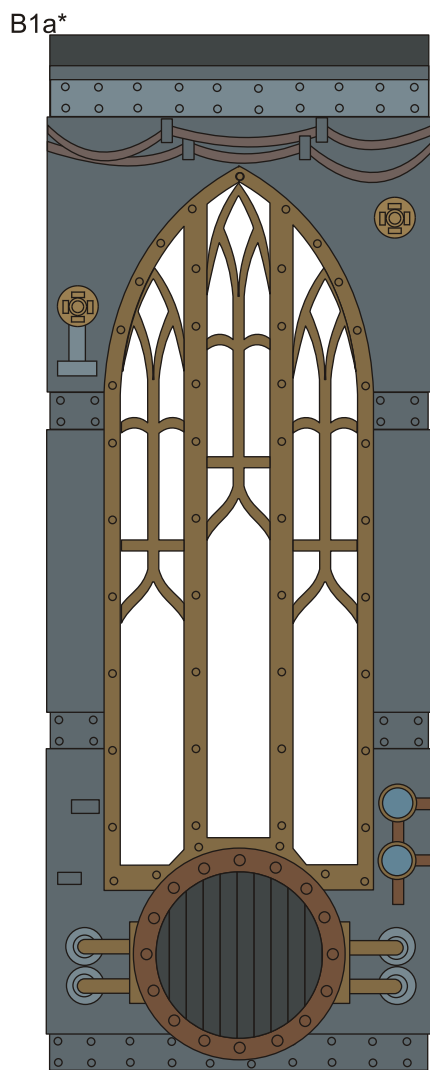
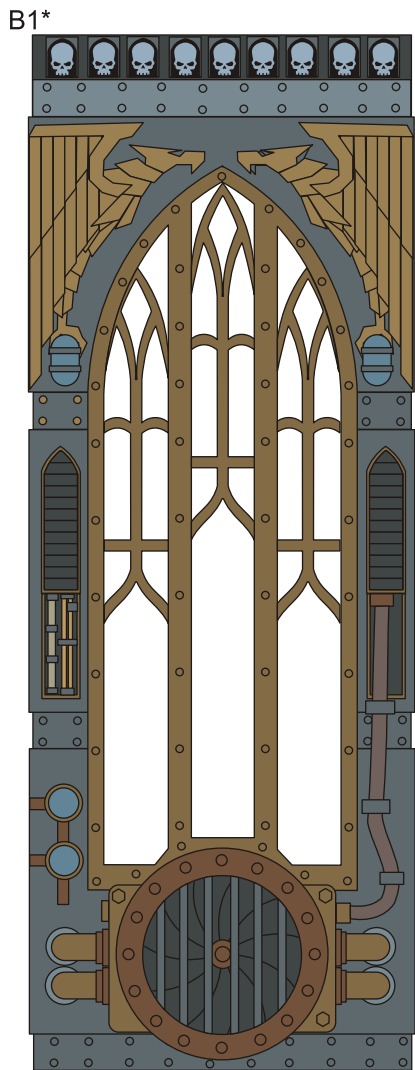

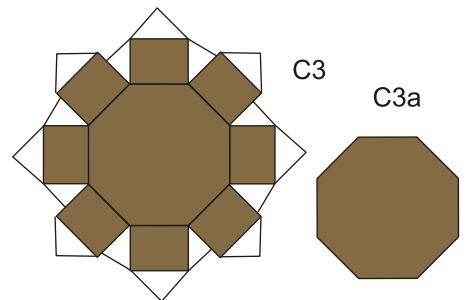
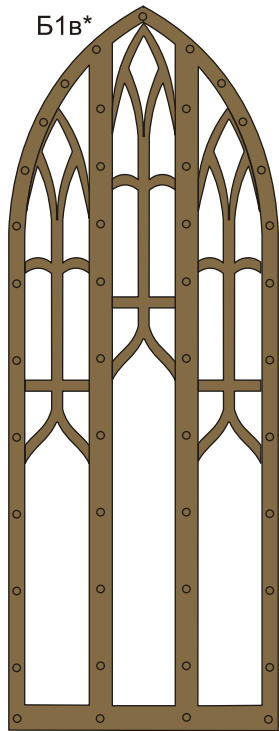
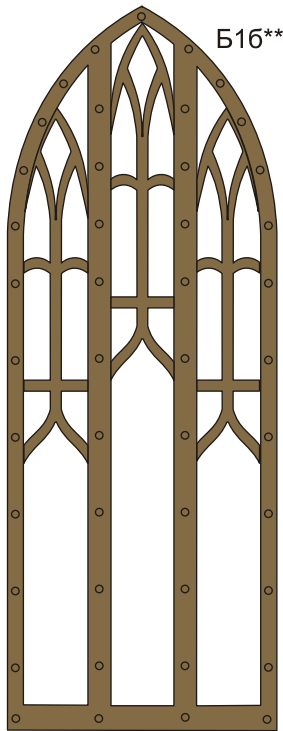
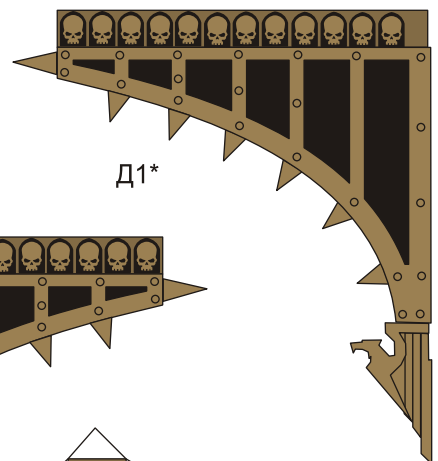
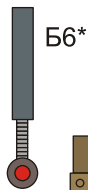
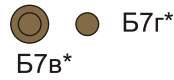
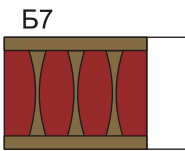
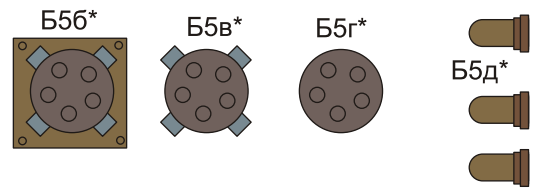
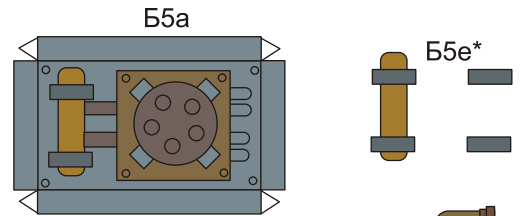
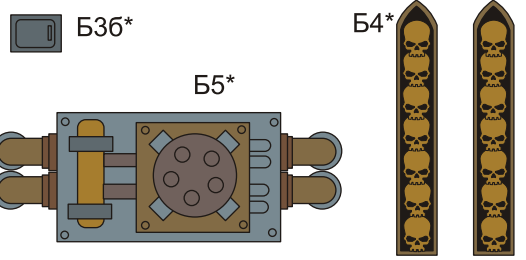
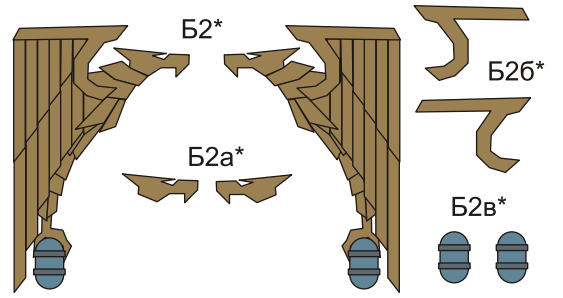
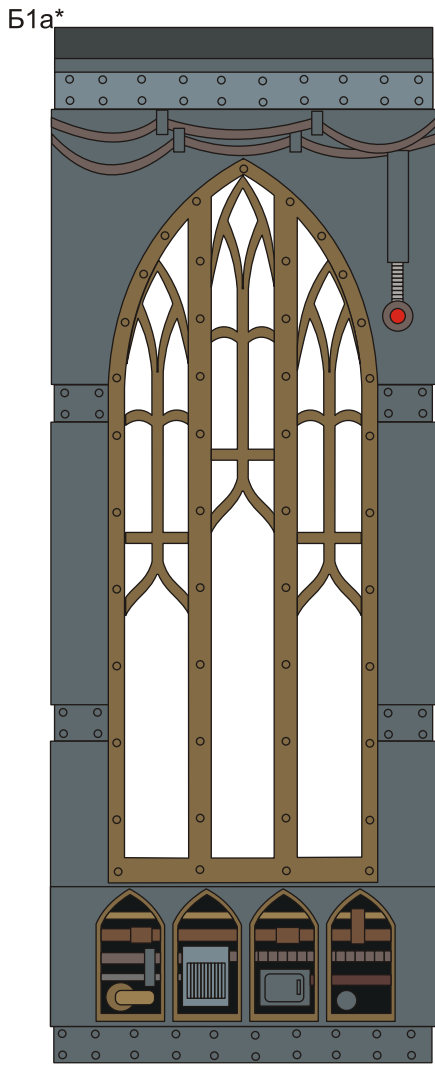
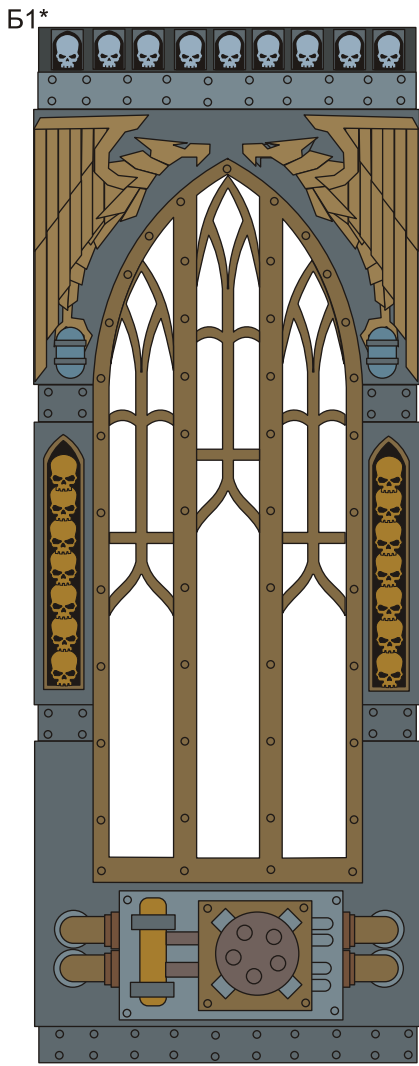

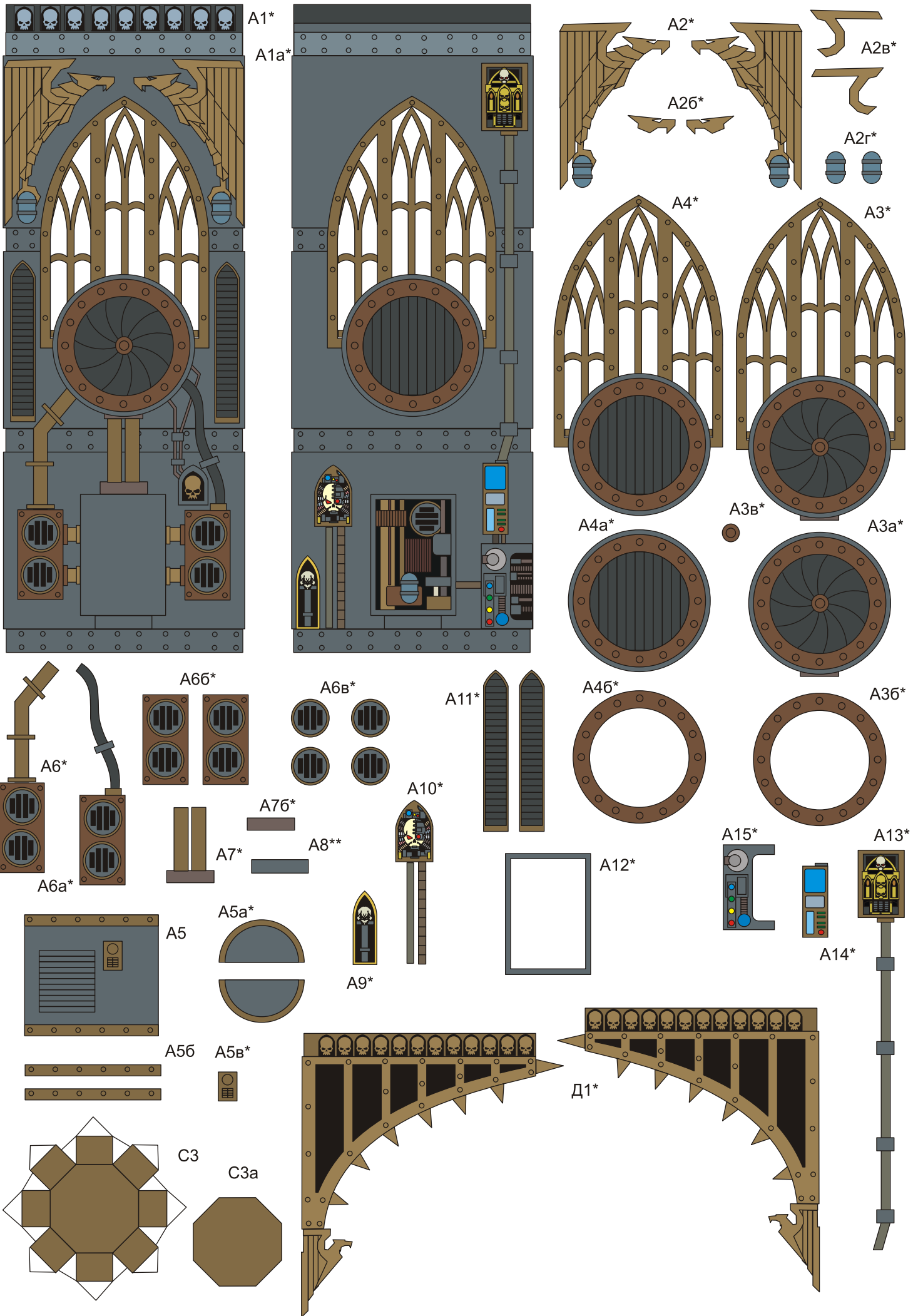

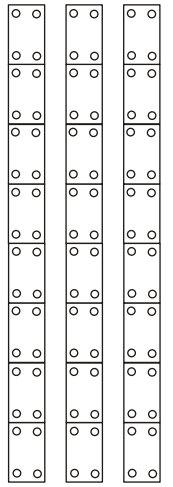
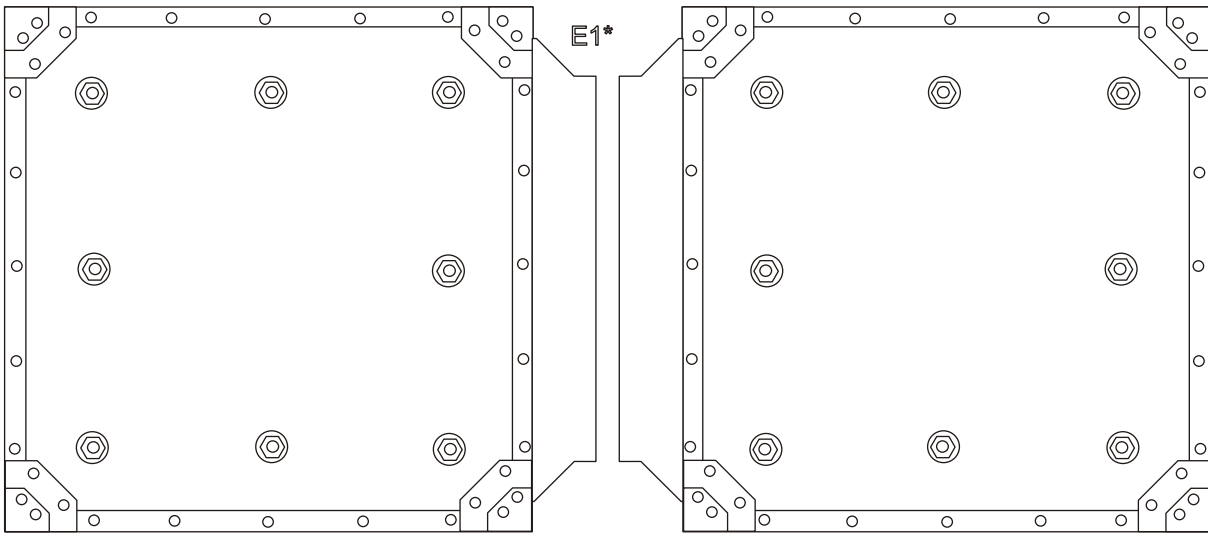
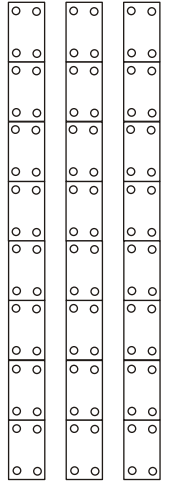
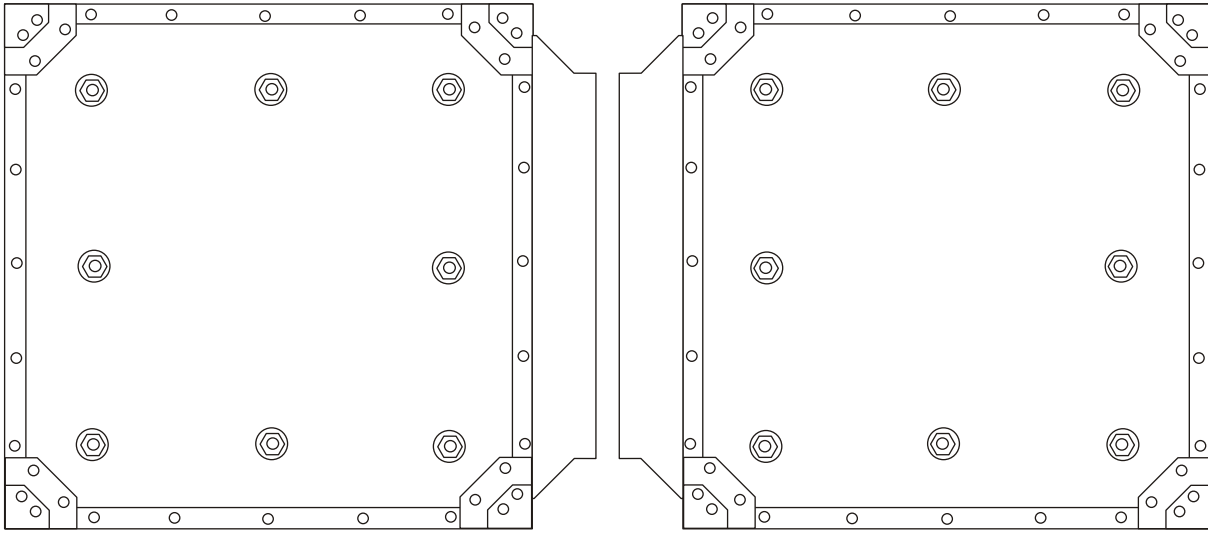

C1a

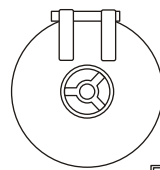
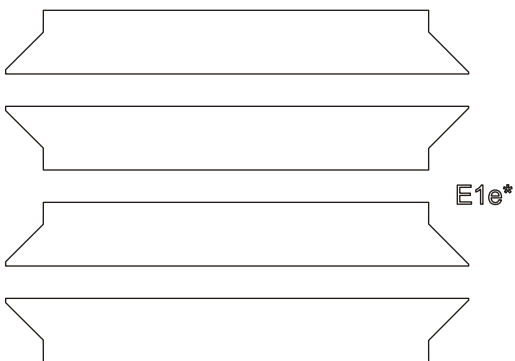
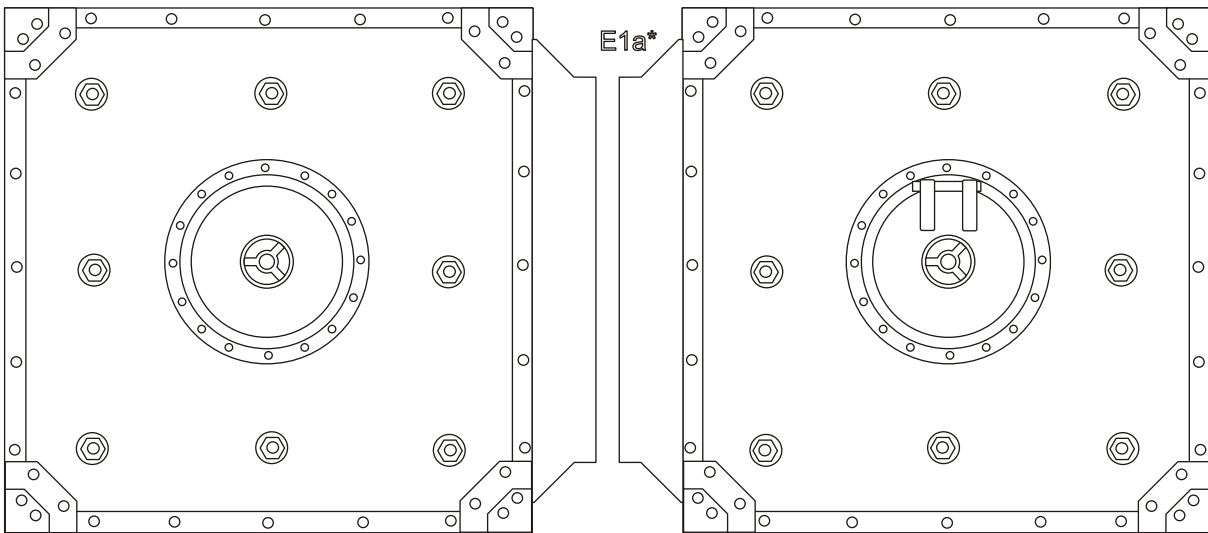

E1d\*



E16\*

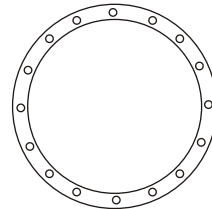

E1b\*

E1b1\*

E1r\*

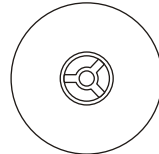

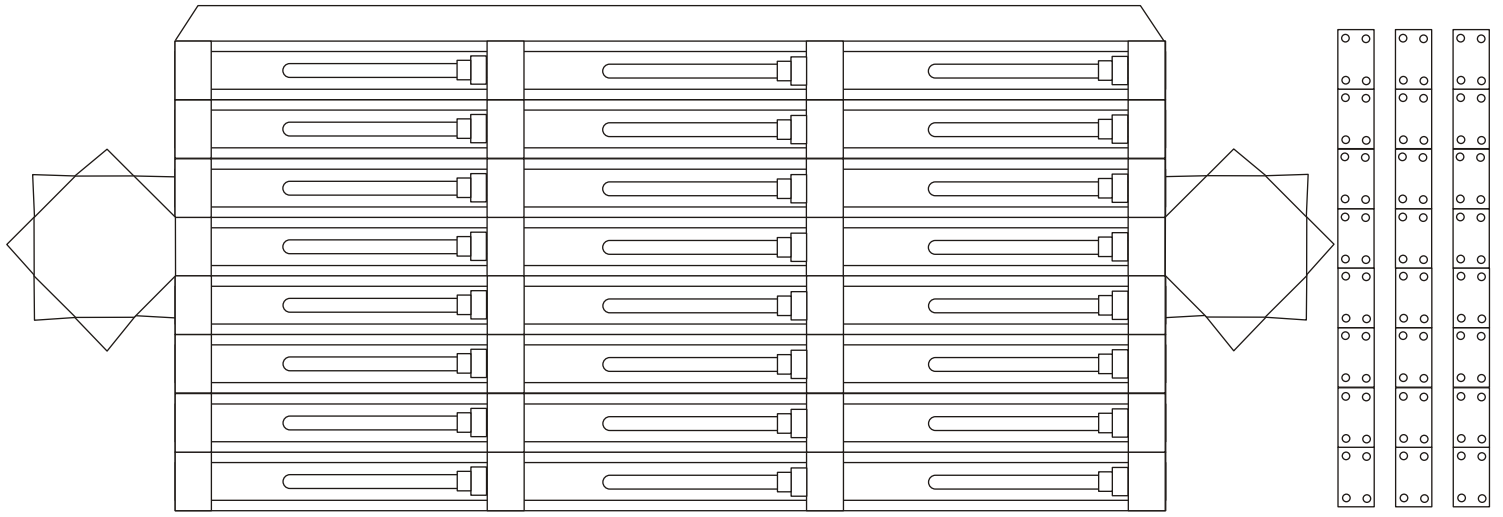

C1

C1a

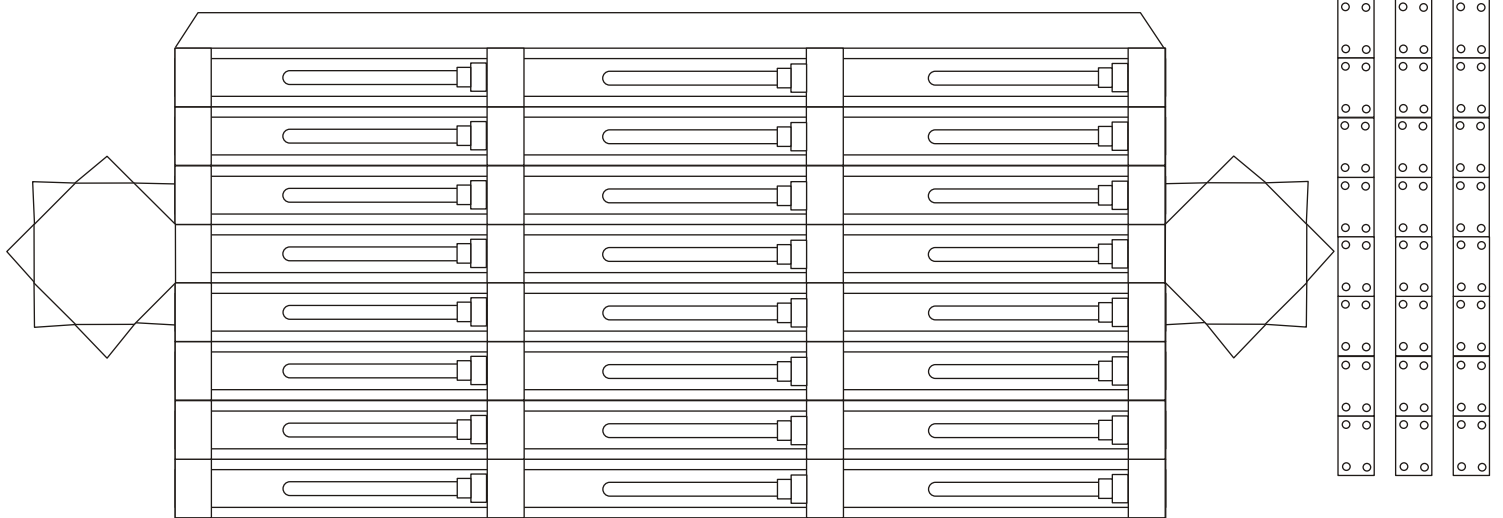
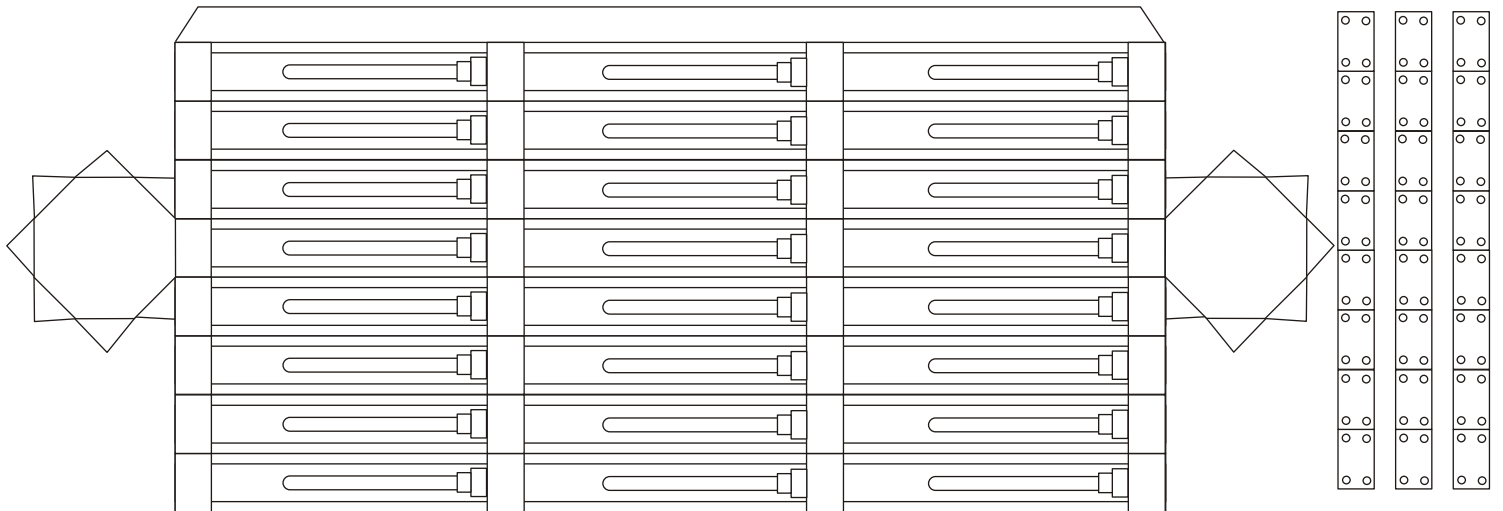
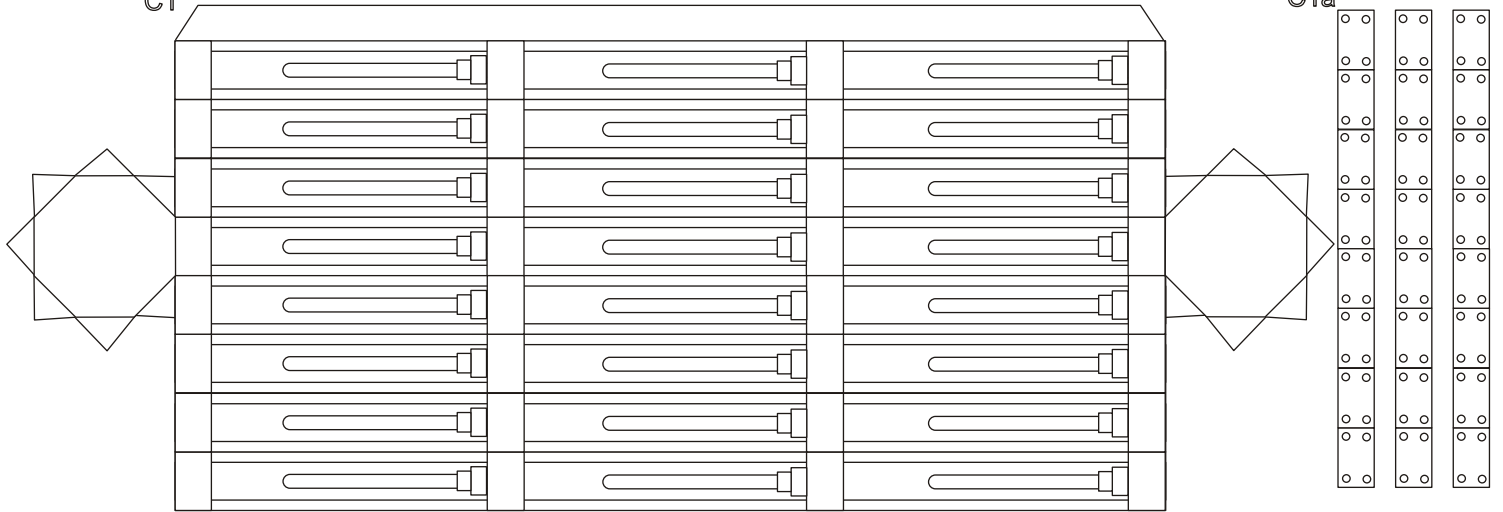

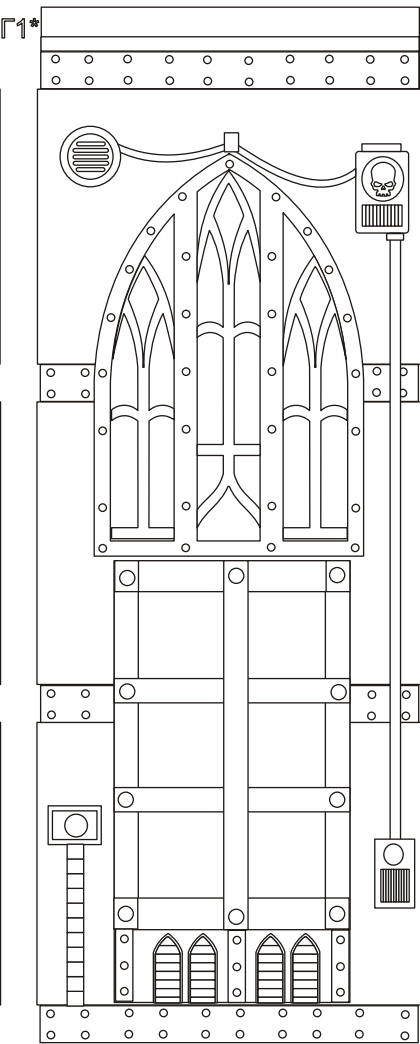
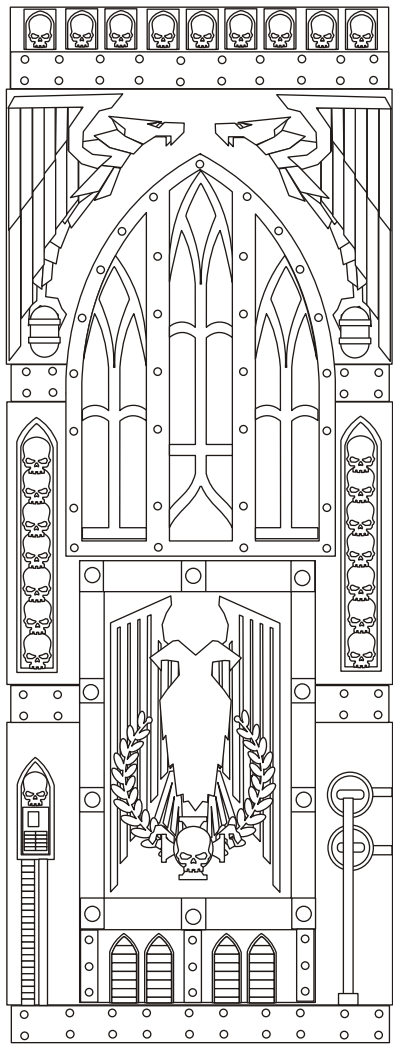

Г1а\*

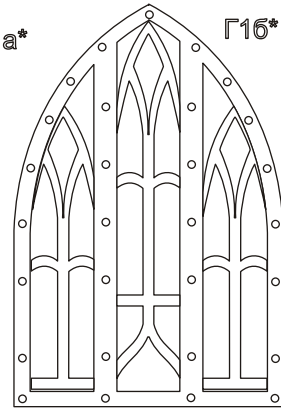

Г15\*

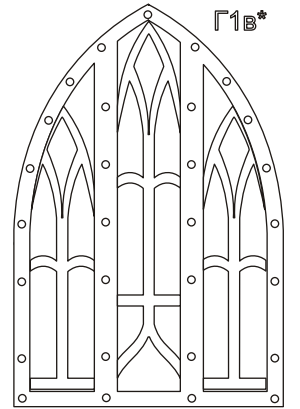

Г1В\*

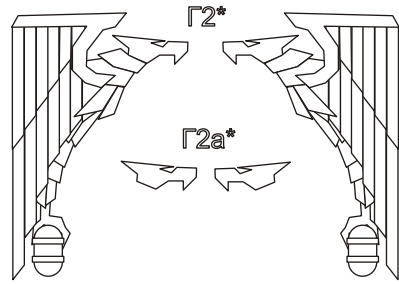

Г2\*

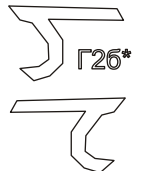

Г2В\*



Г2а\*



Г2в\*



Г3\*

Г4\*



Г5\*



Г7\*



Г7а\*



Г8\*



Г9\*



Г10а\*



Г10\*



Г6\*



Г13\*

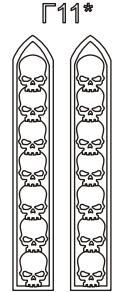

Г11\*



Г12\*



Г14\*

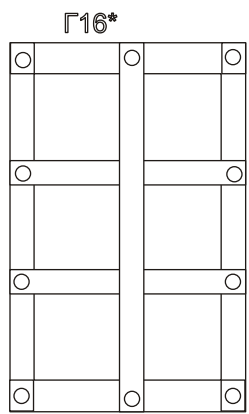

Г16\*



Г16а\*

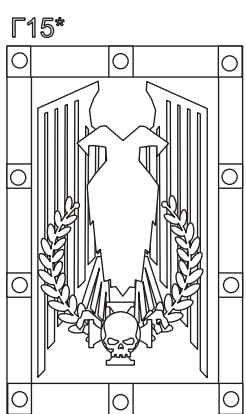

Г15\*

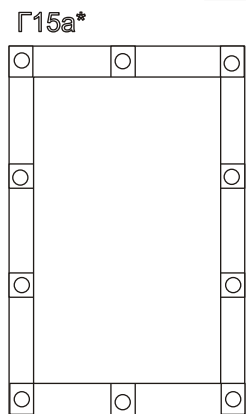

Г15а\*

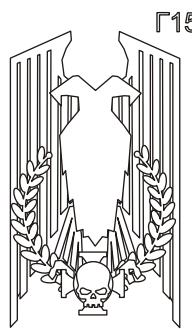

Г15В\*



Г15г\*



Г15д\*

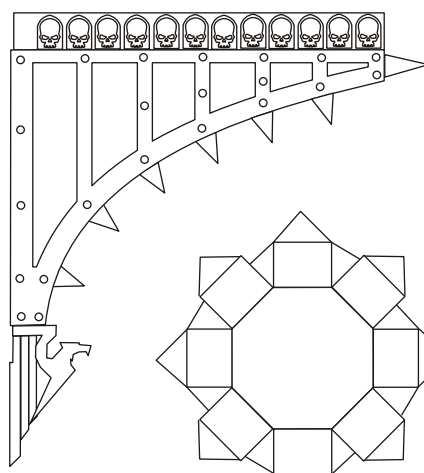

Д1\*

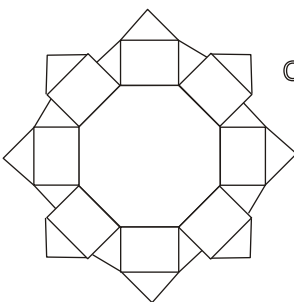

С3

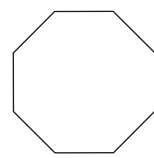

С3а

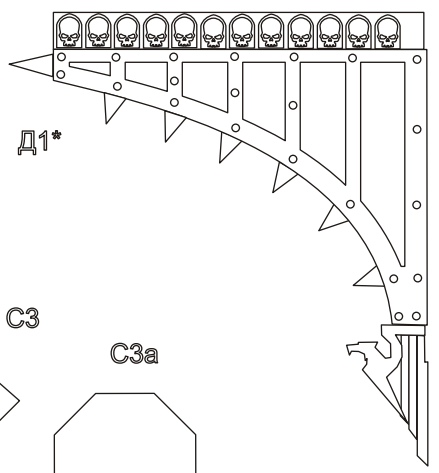

Д1\*

