

deptus mechanicus departamento manufacturum

PATOROCH

AEGIS DEFENCE LINE

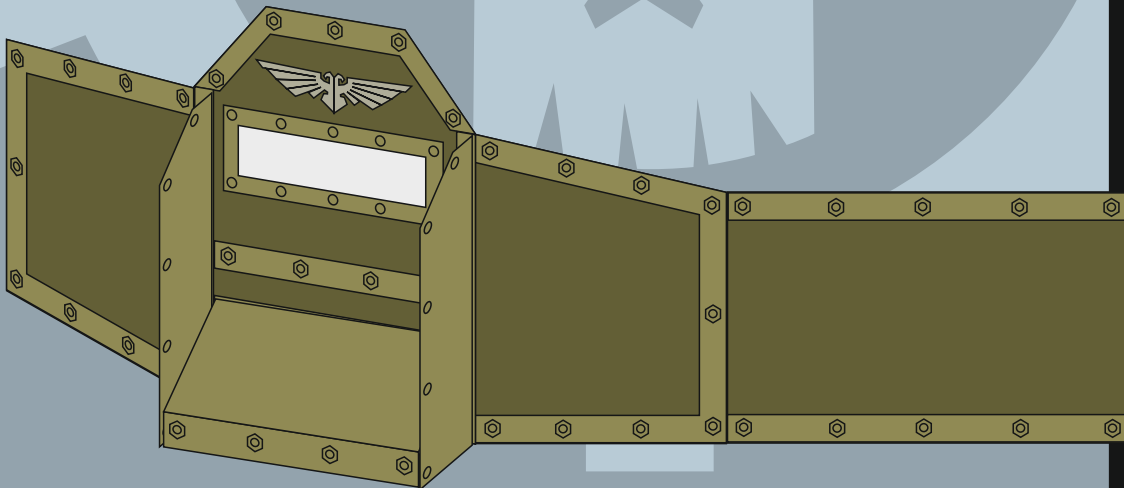
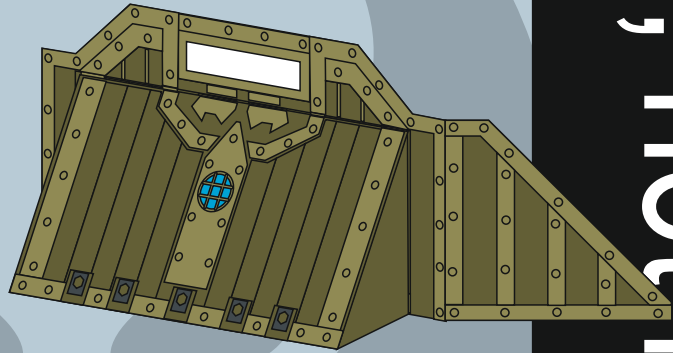
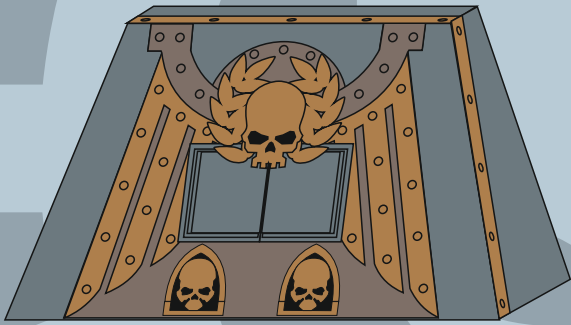
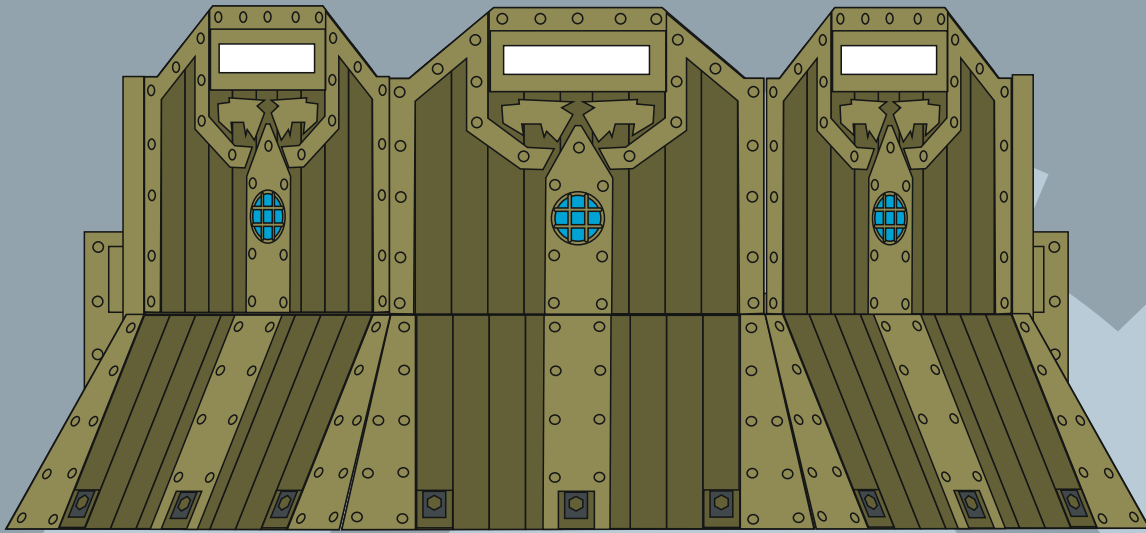

Free model, not for sale



Made in Ukraine

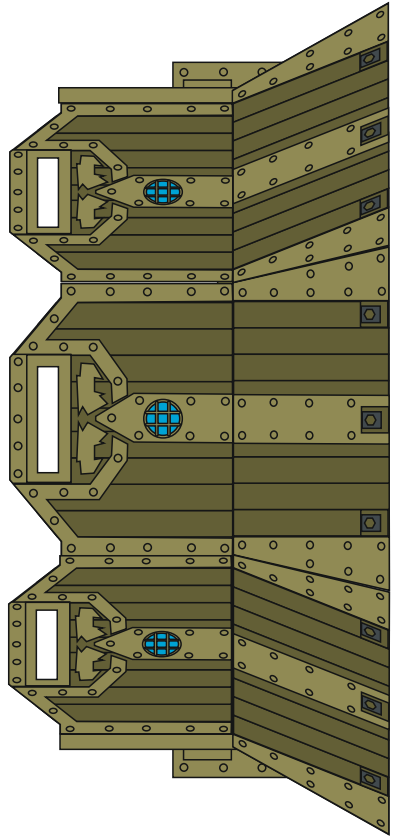
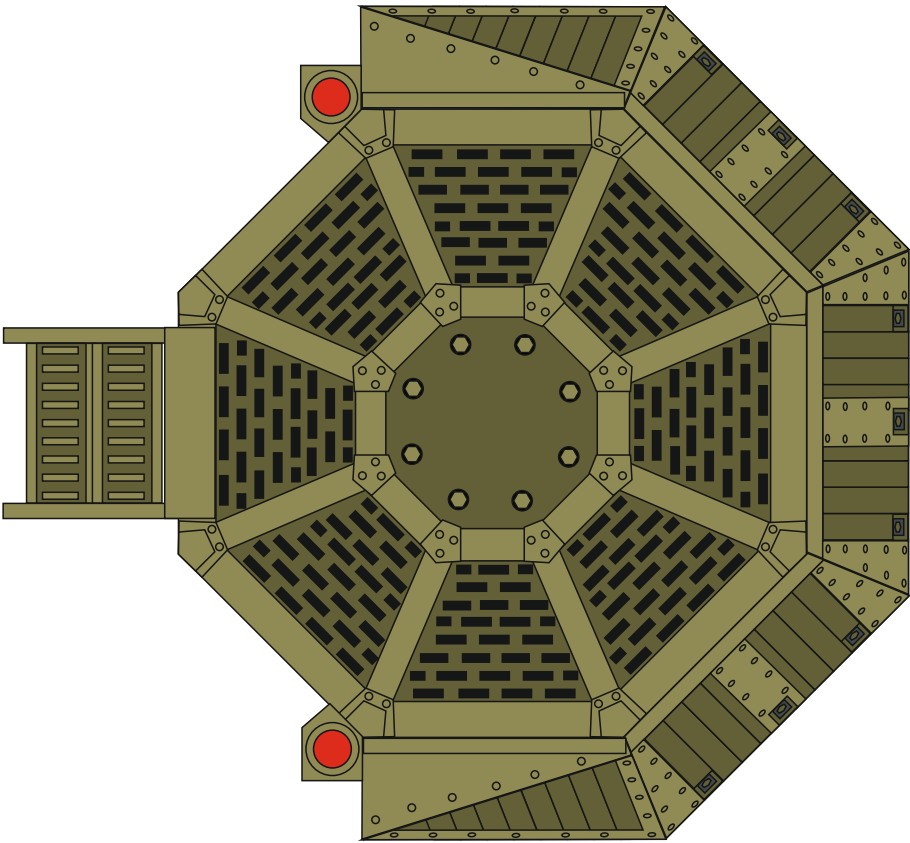
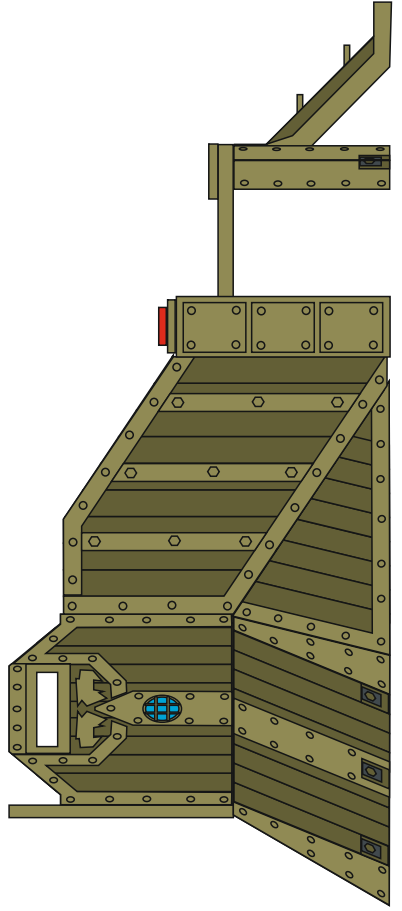
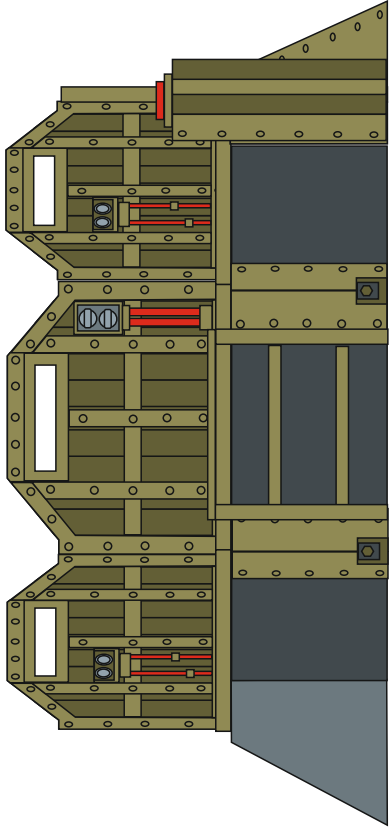

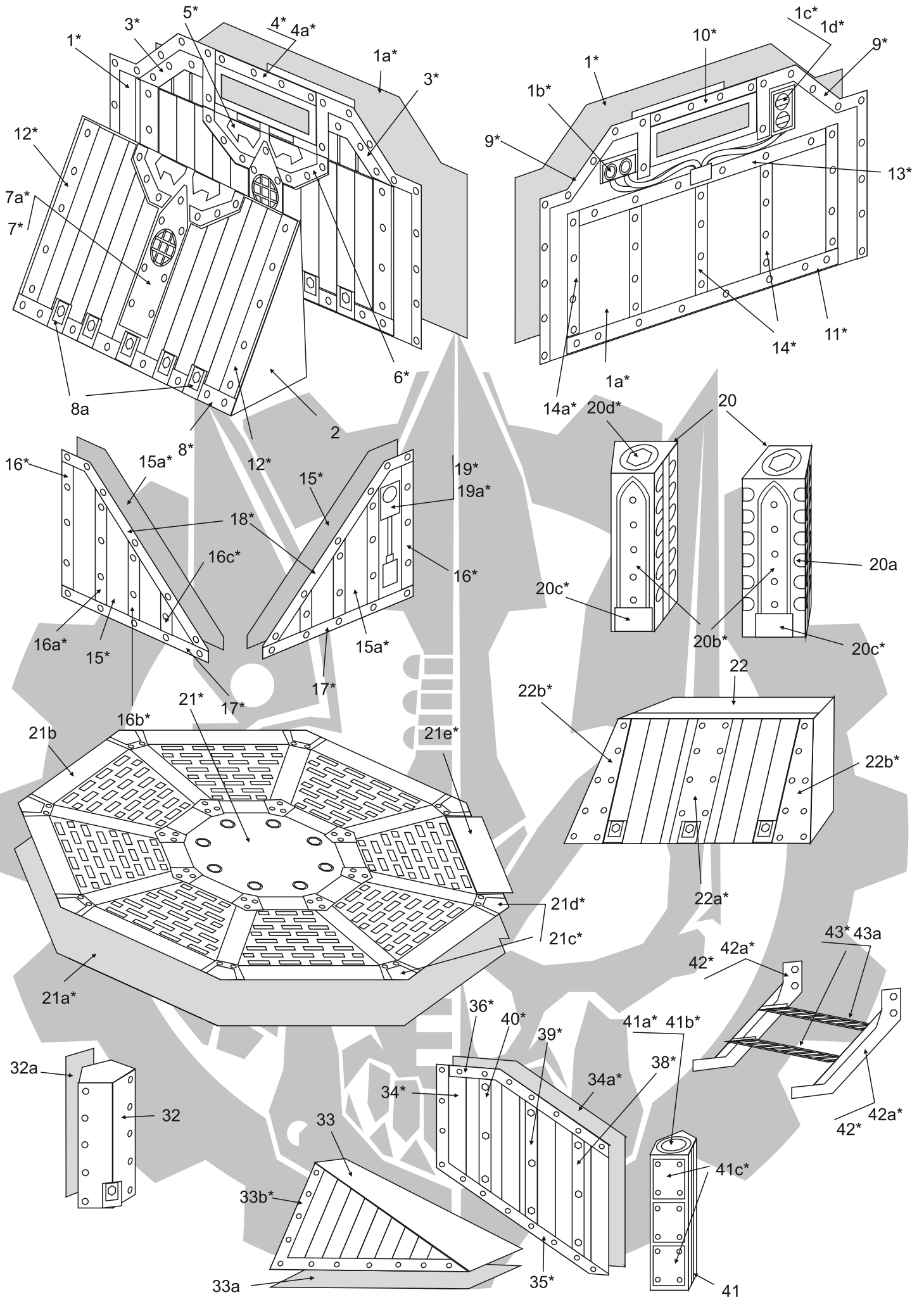

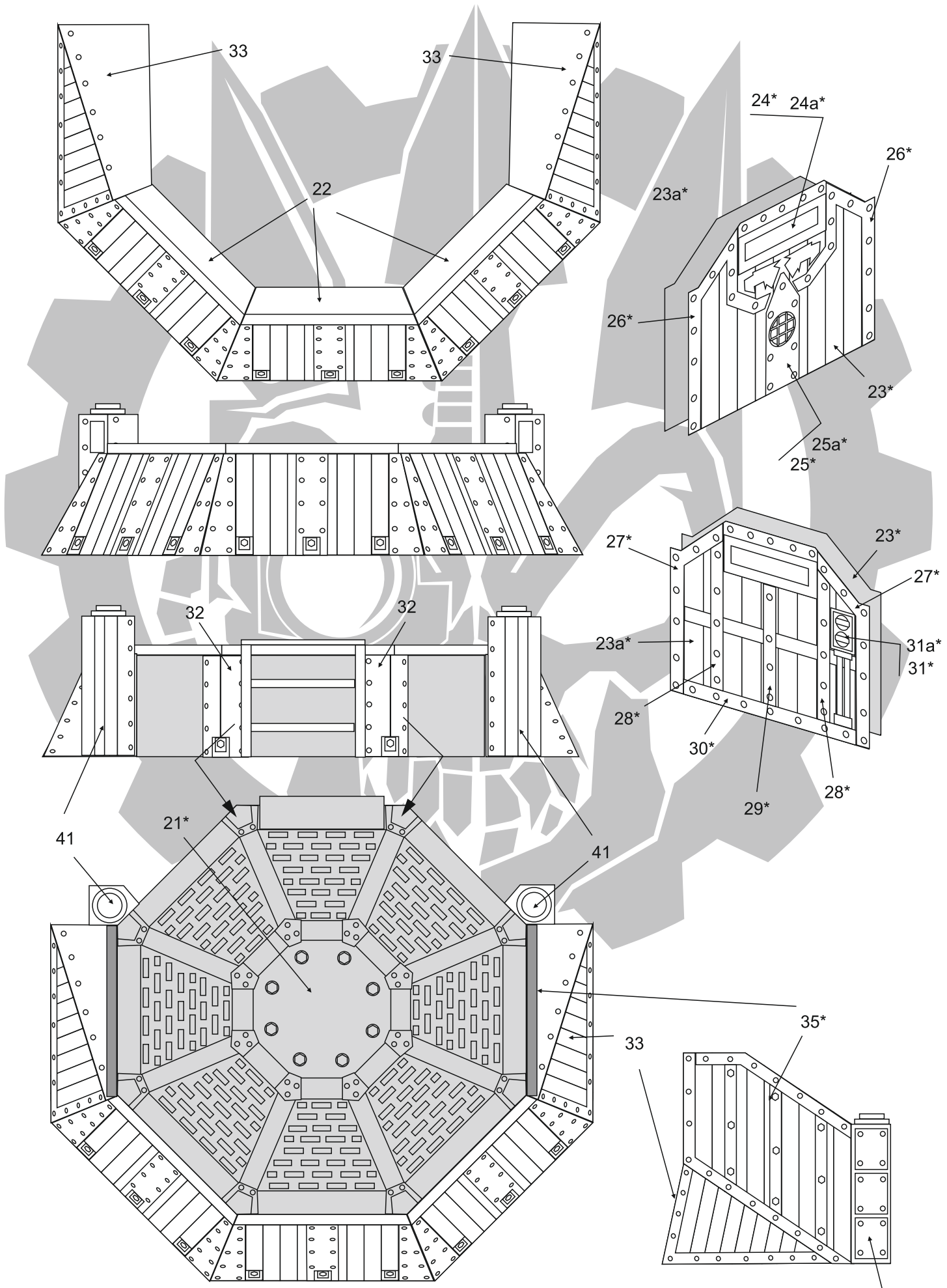

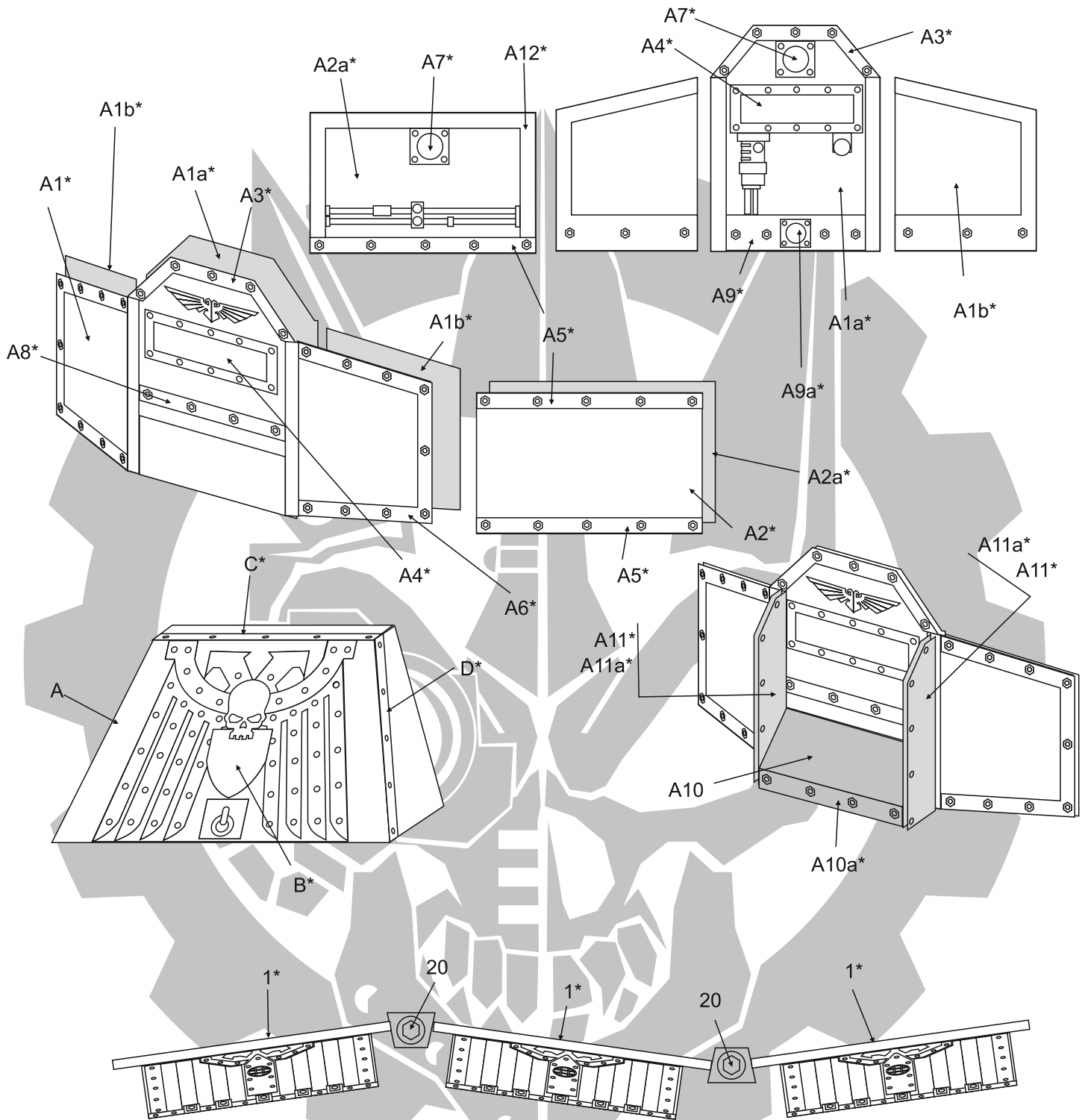

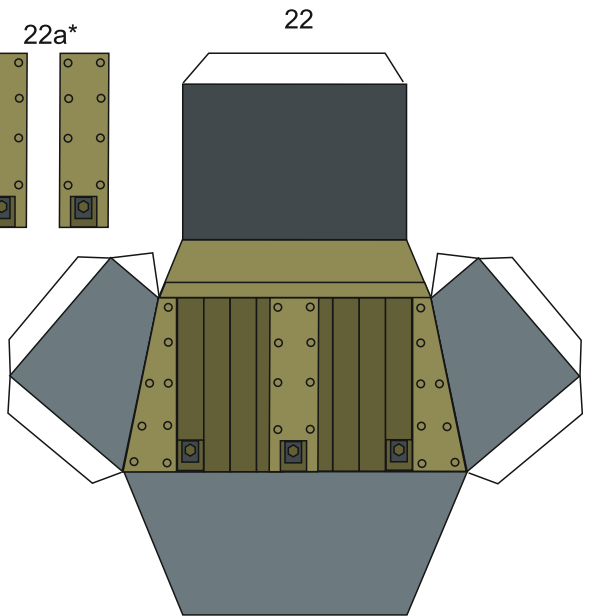
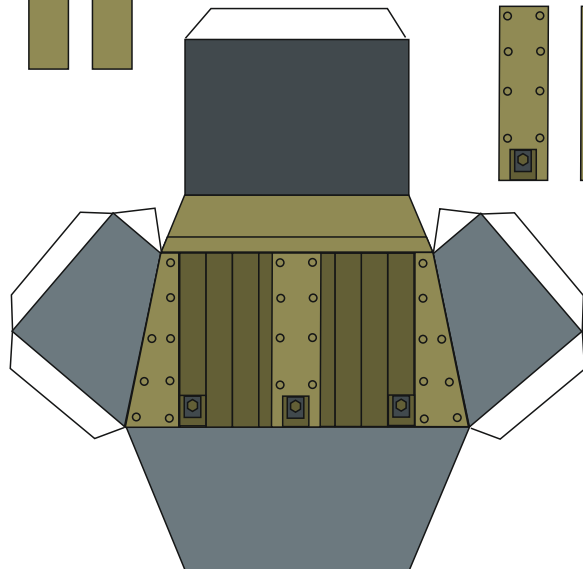
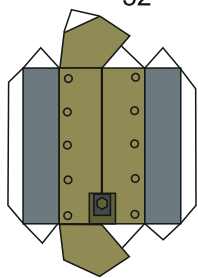
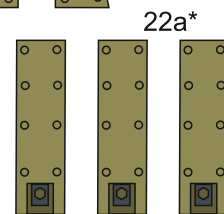
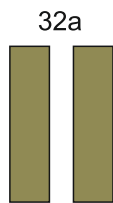
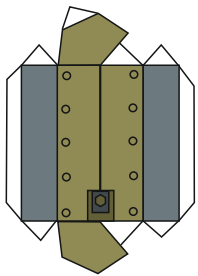
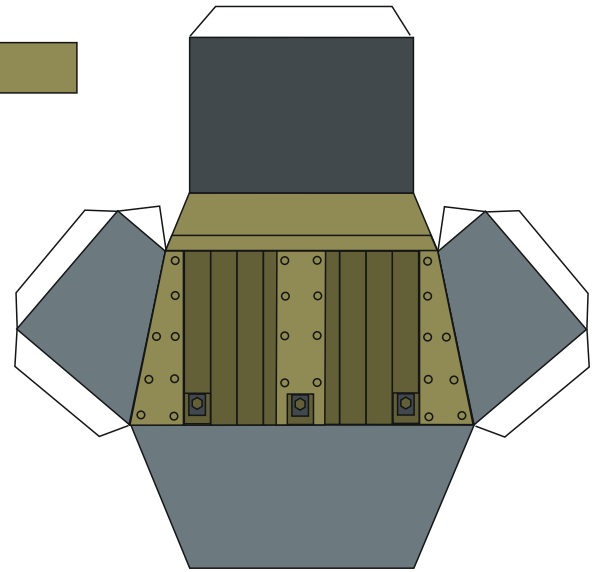
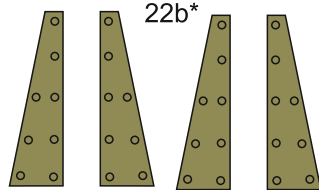
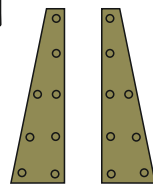
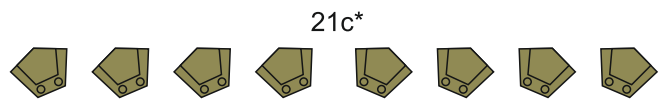
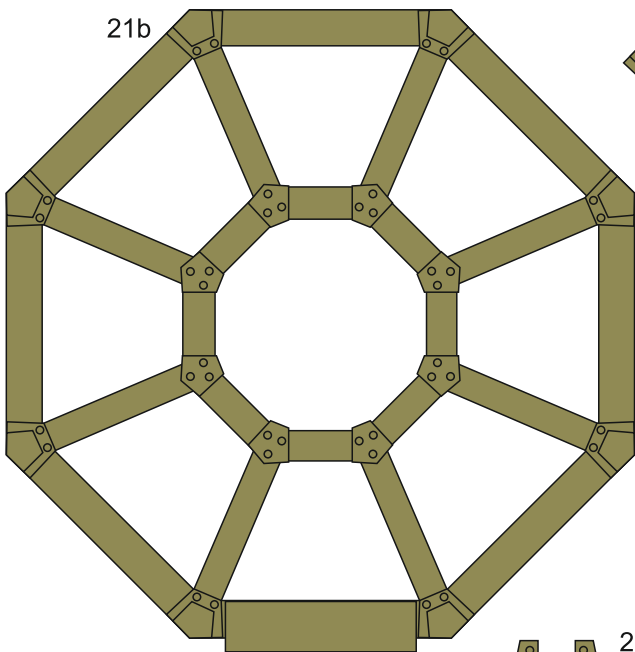
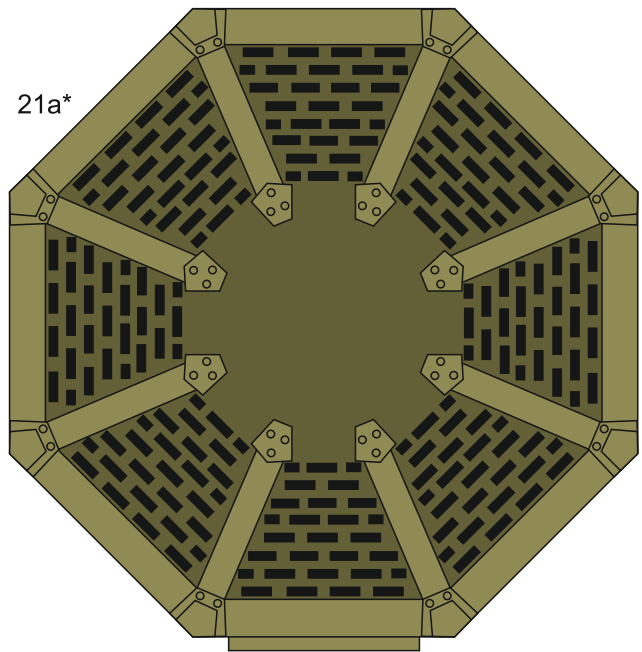
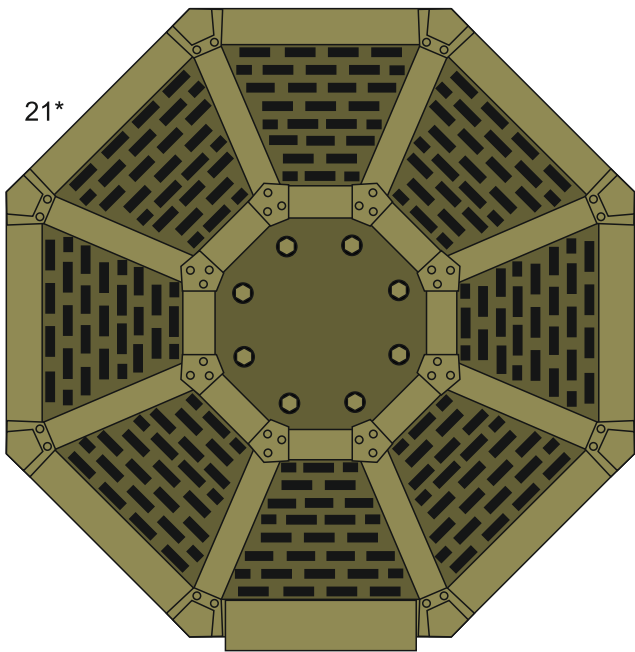

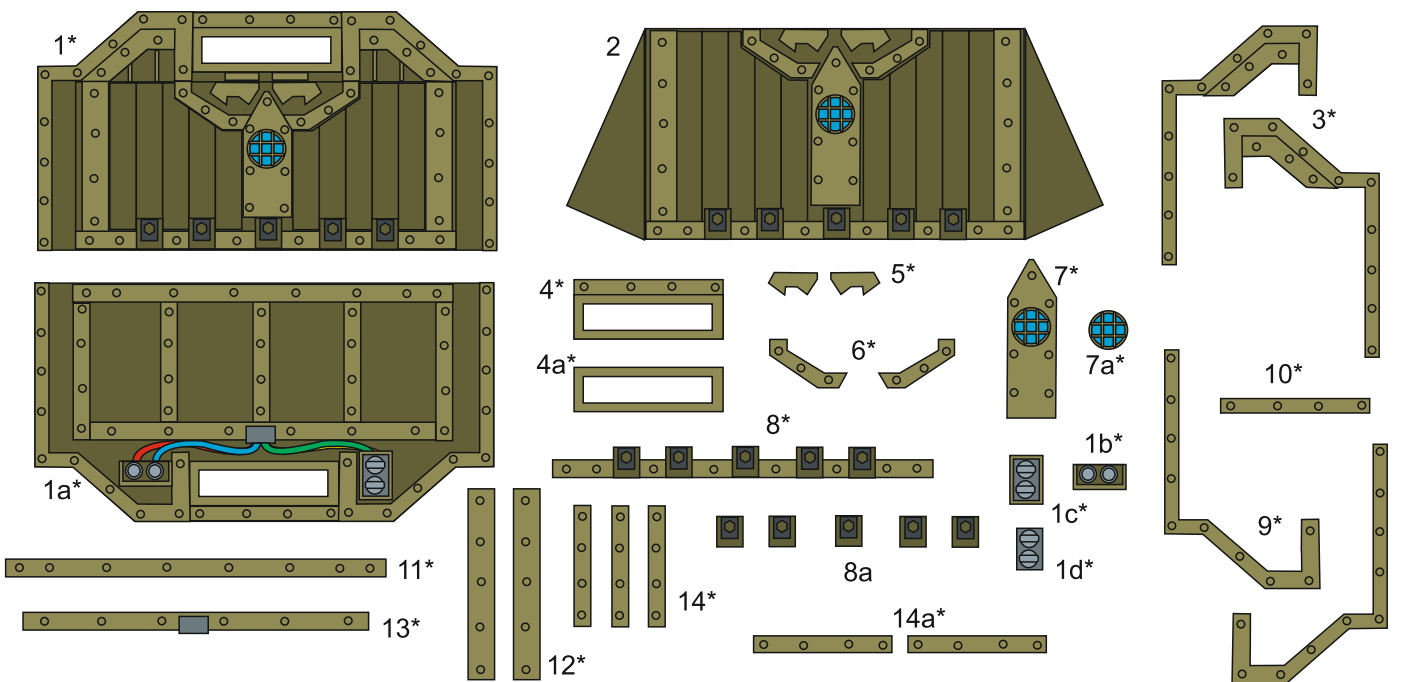
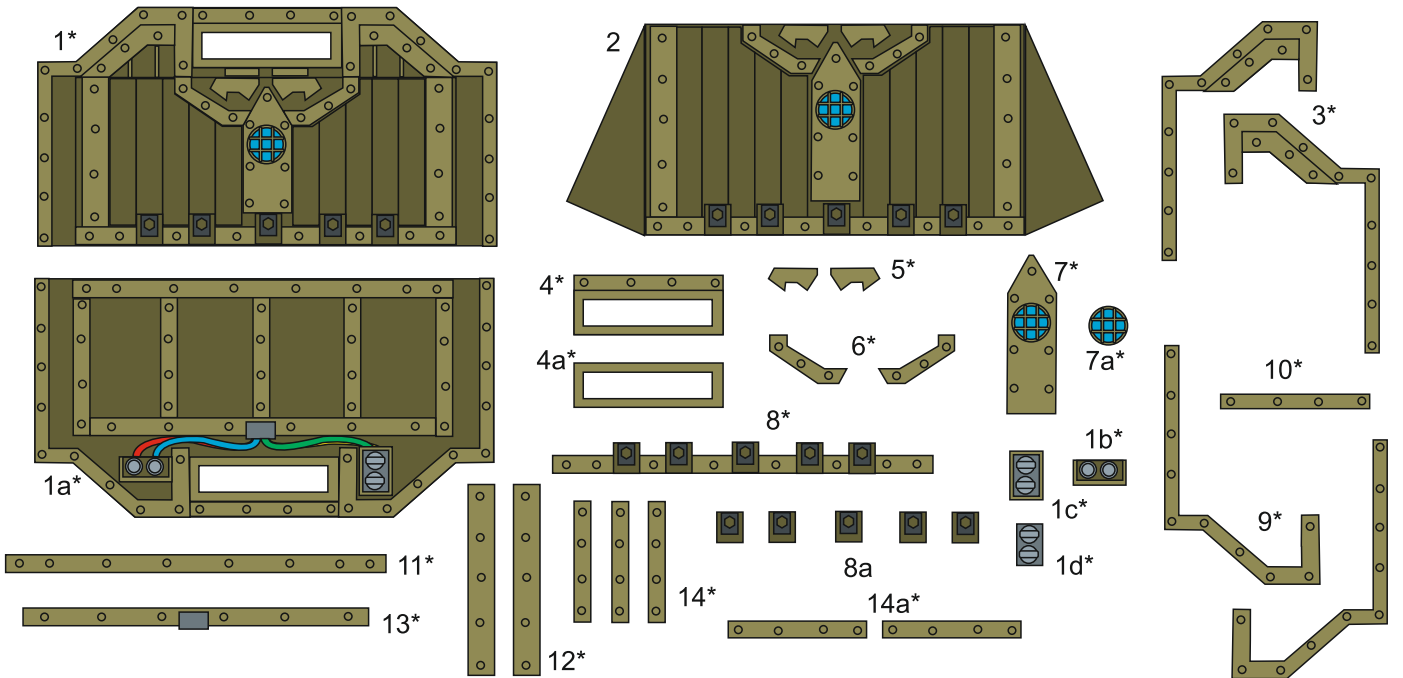
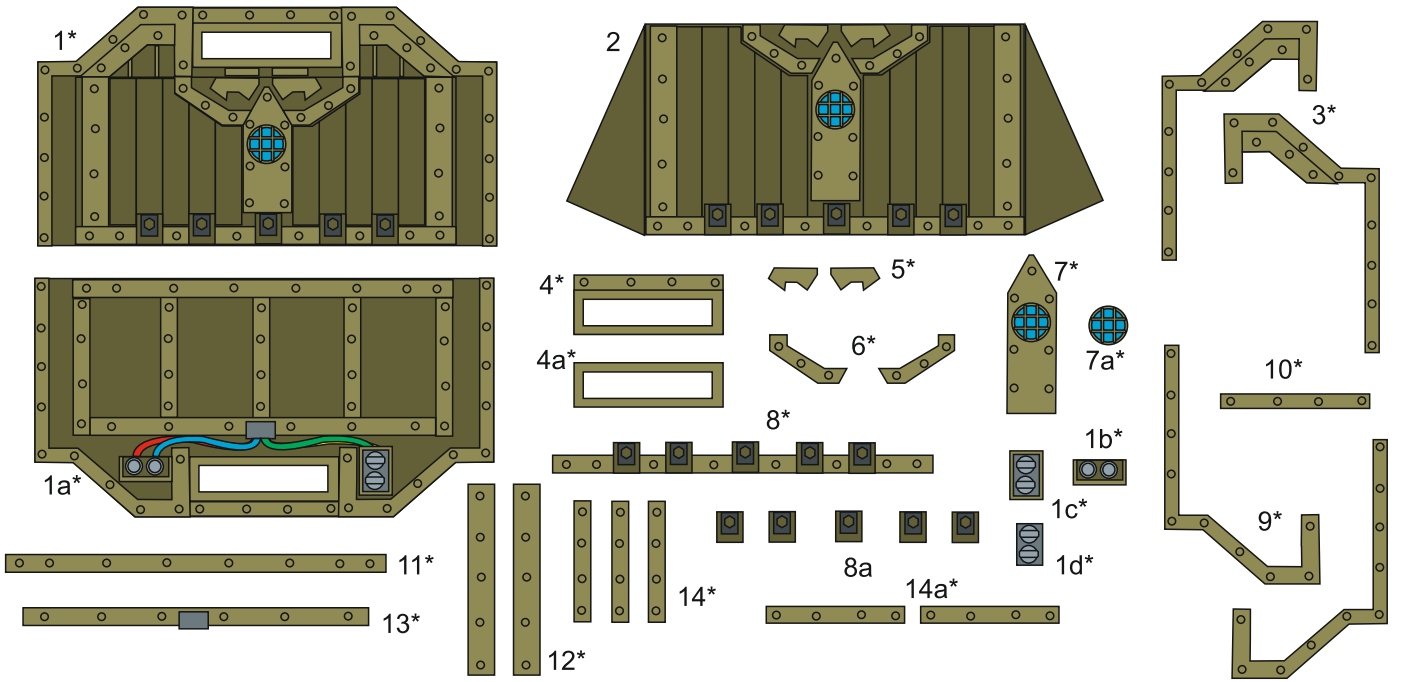

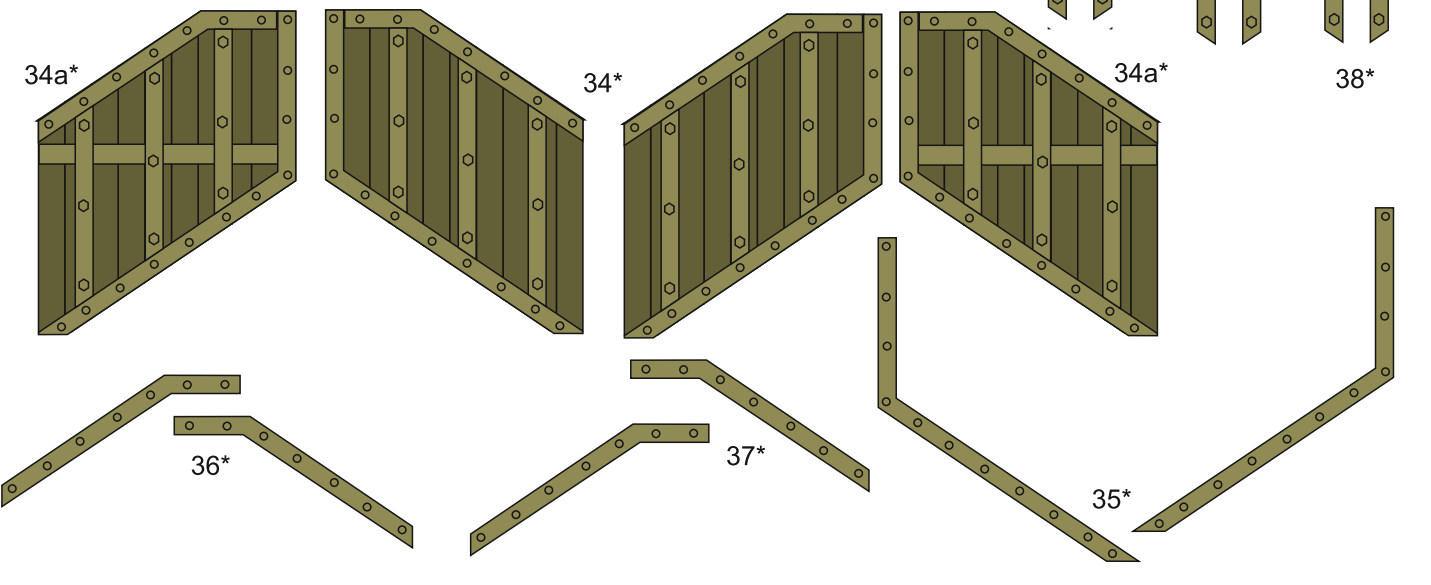
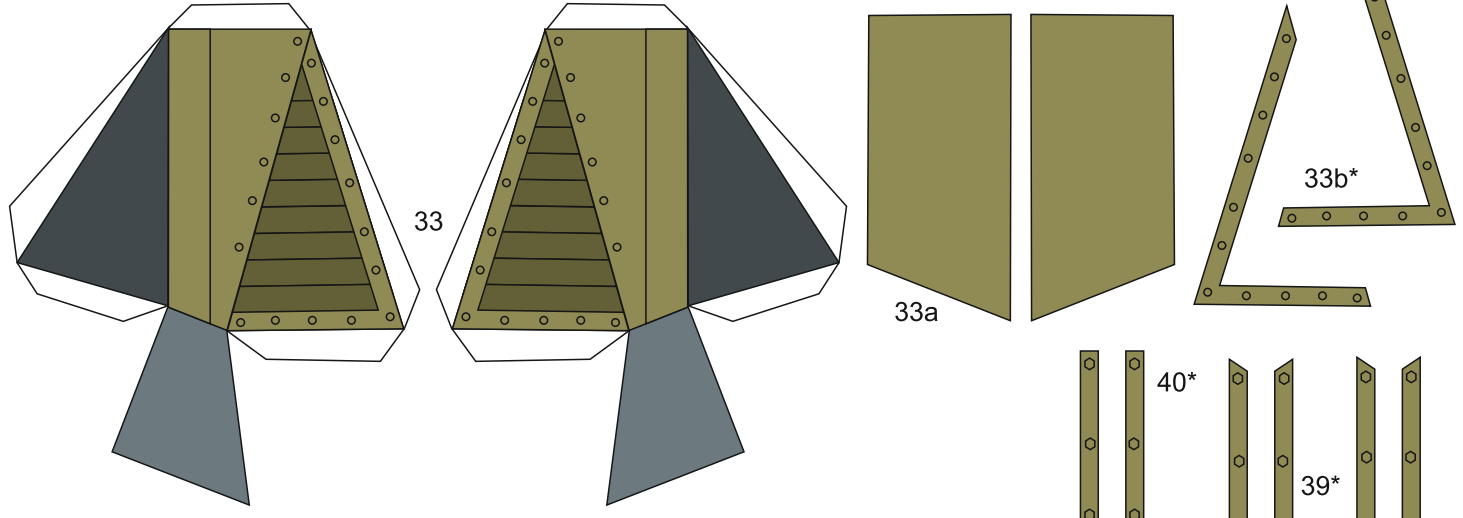
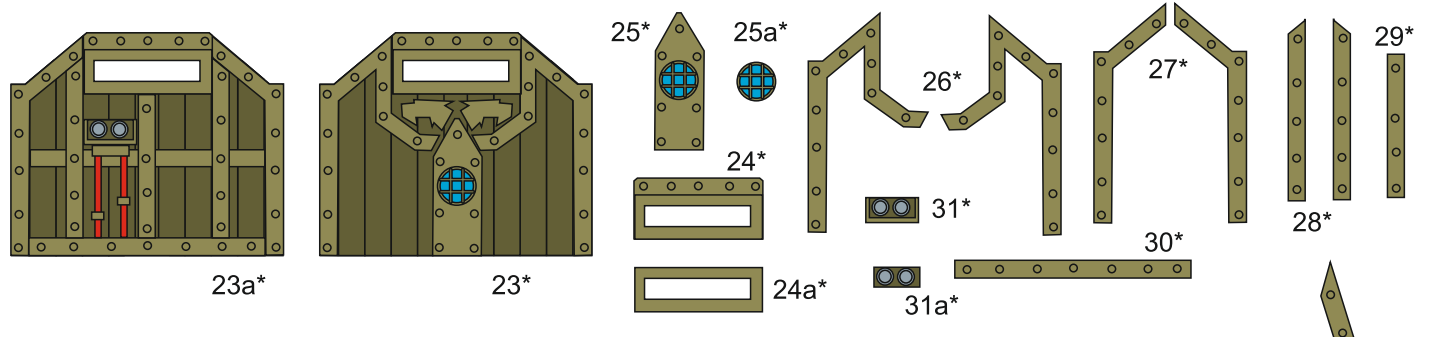
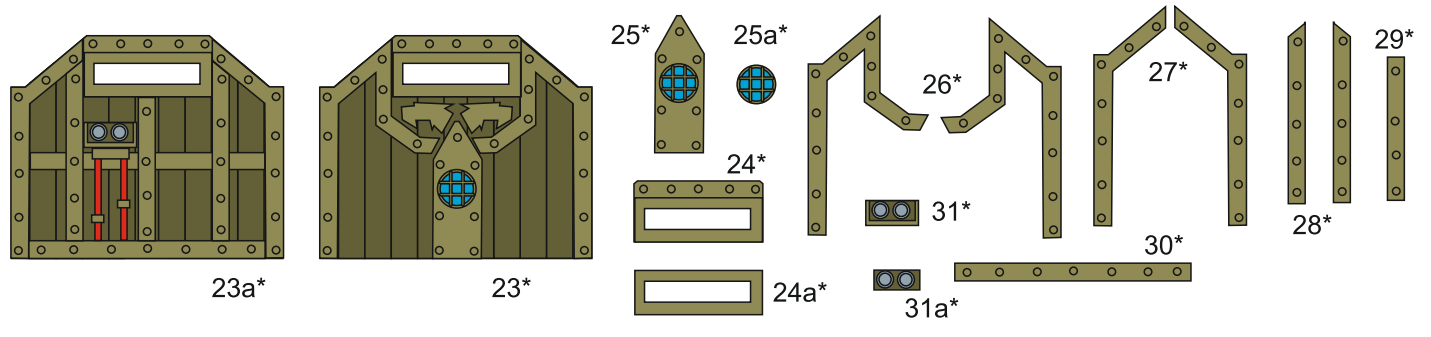
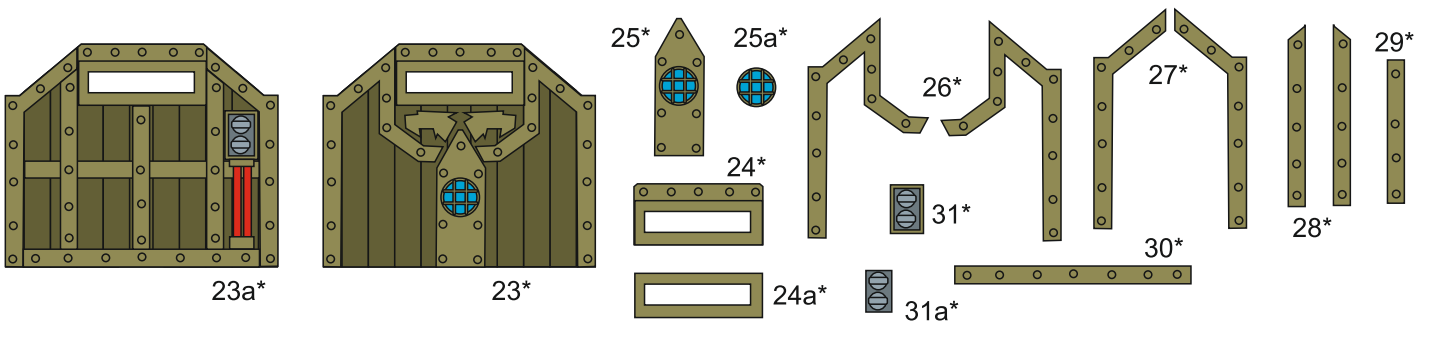

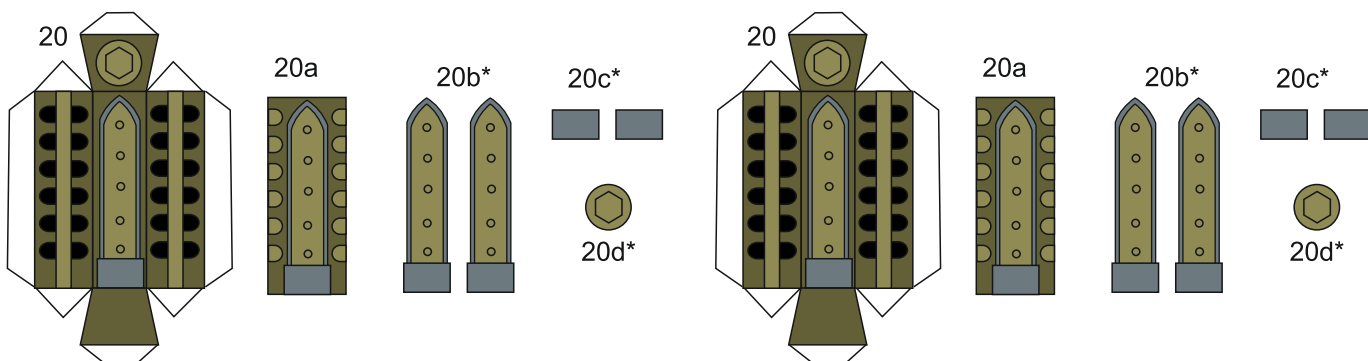
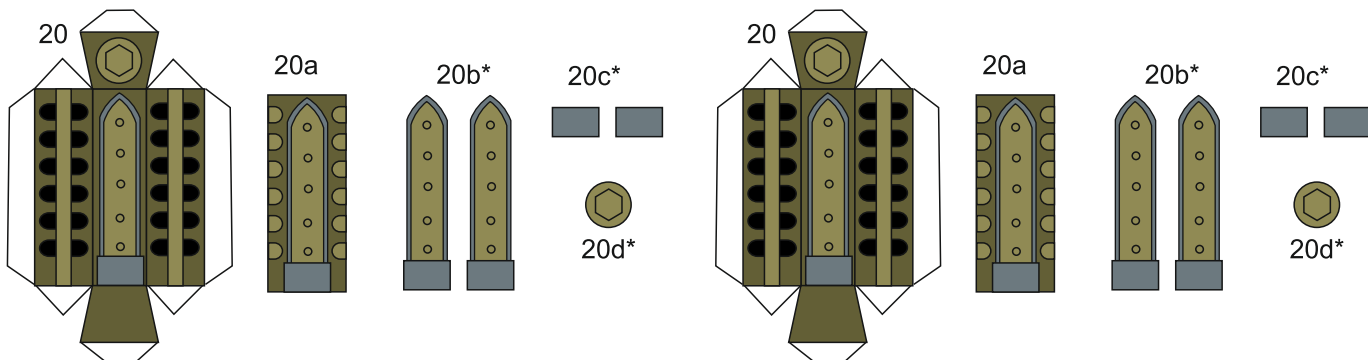
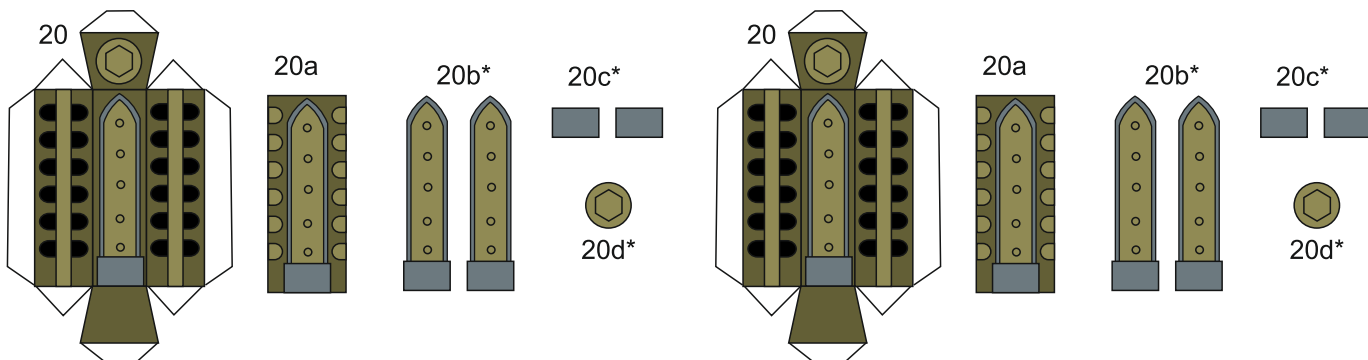
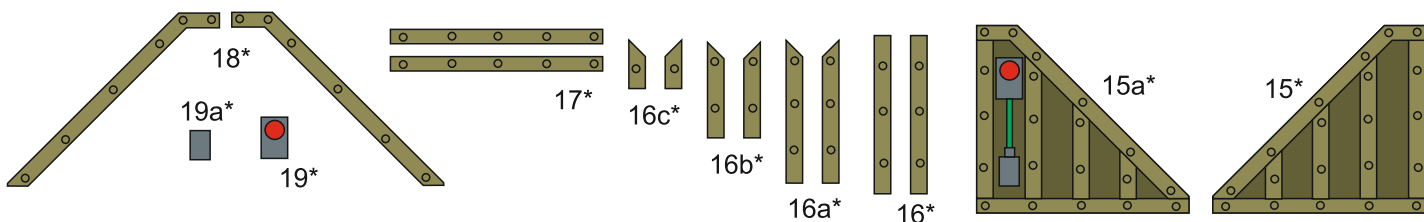
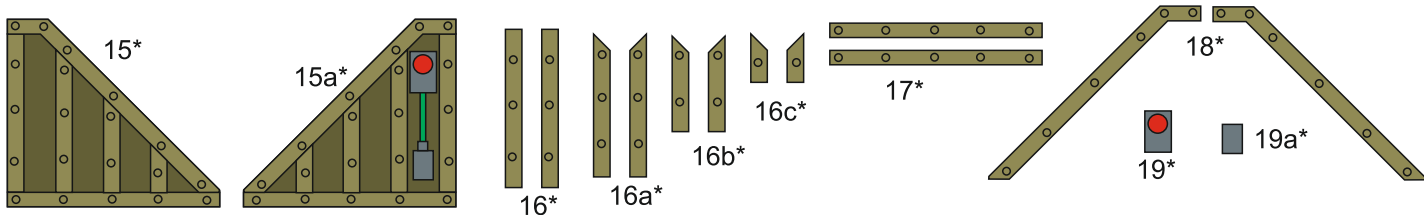
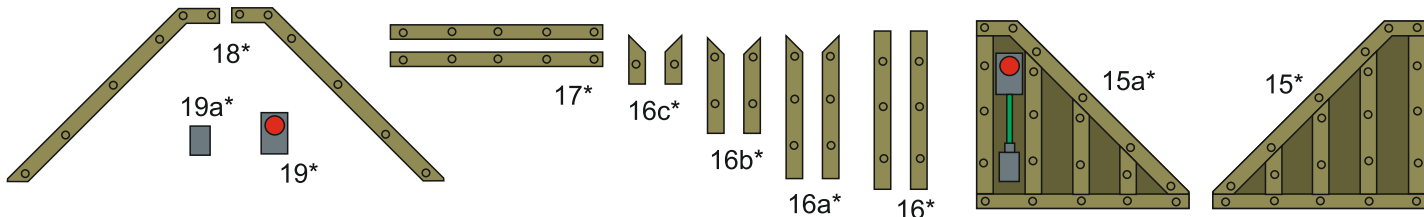
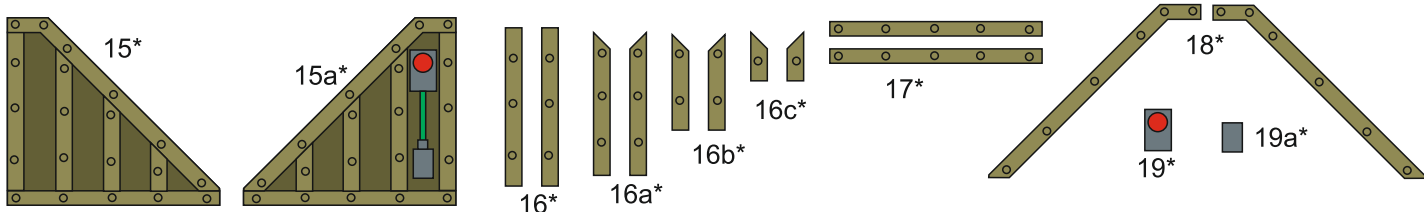

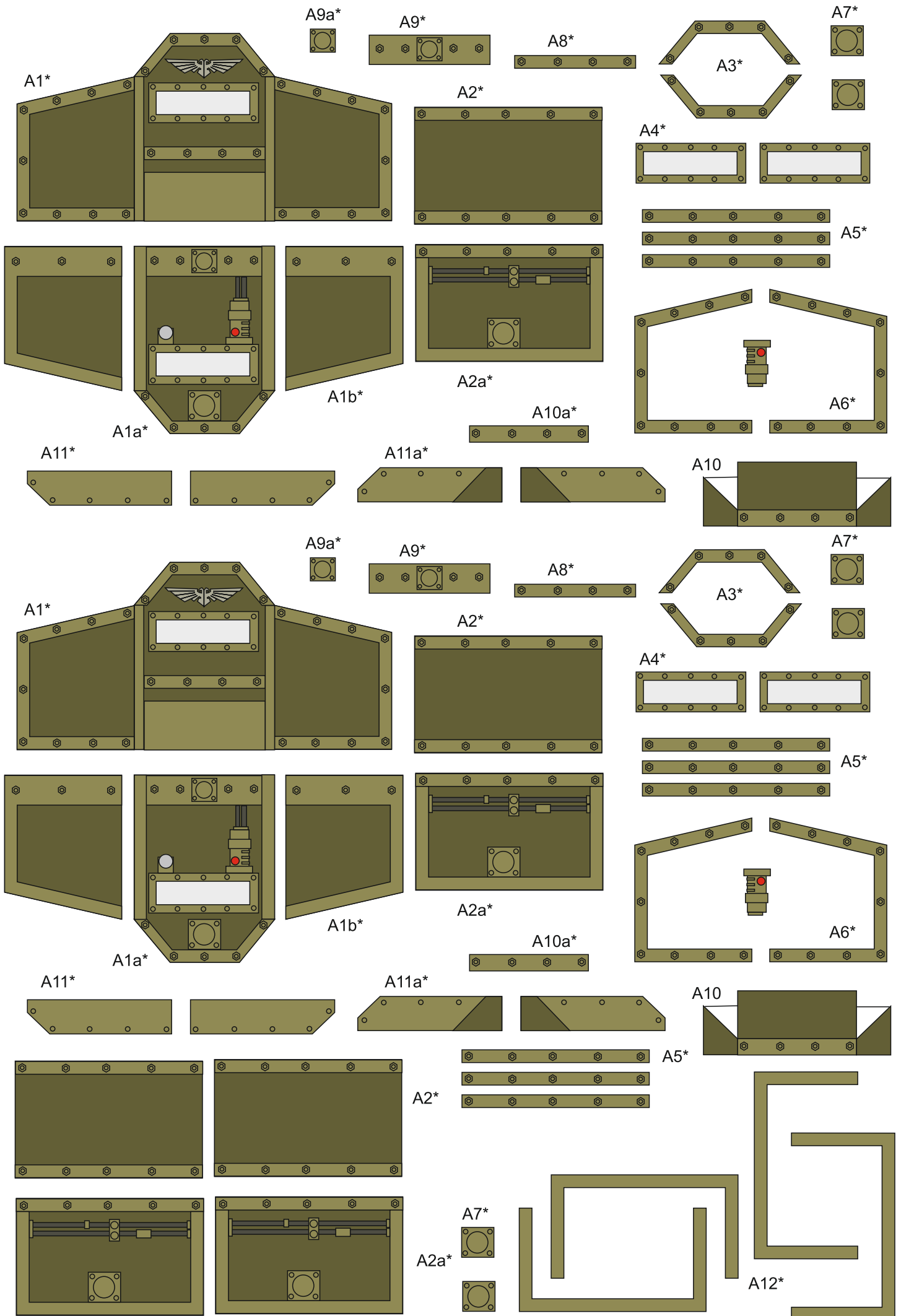

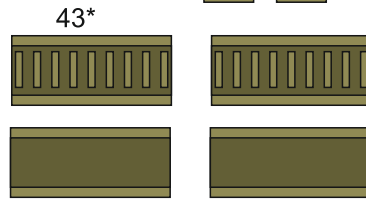
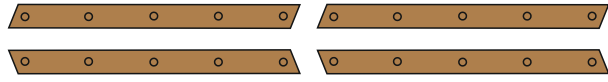
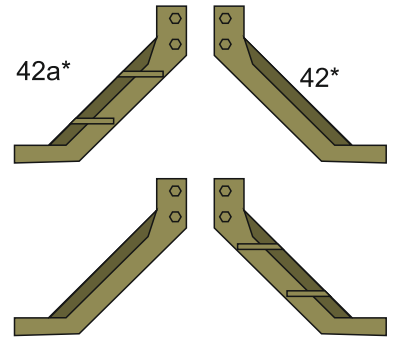
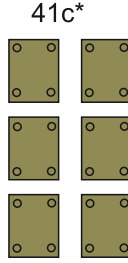
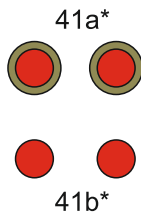
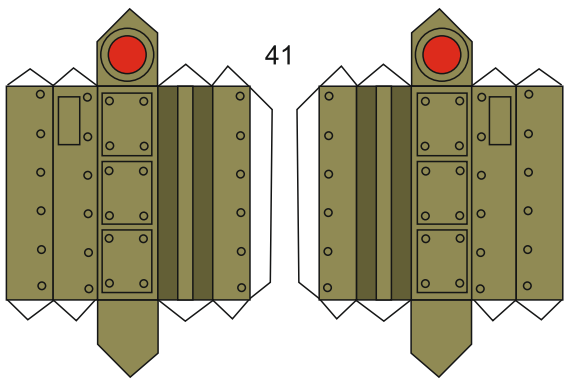

43a

C*

D*

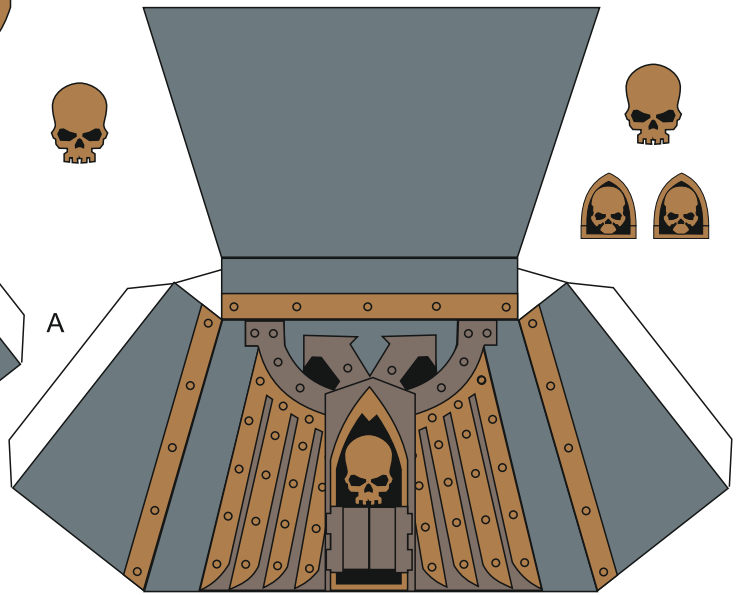
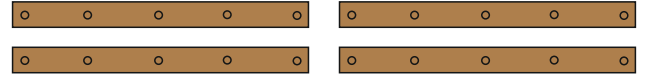
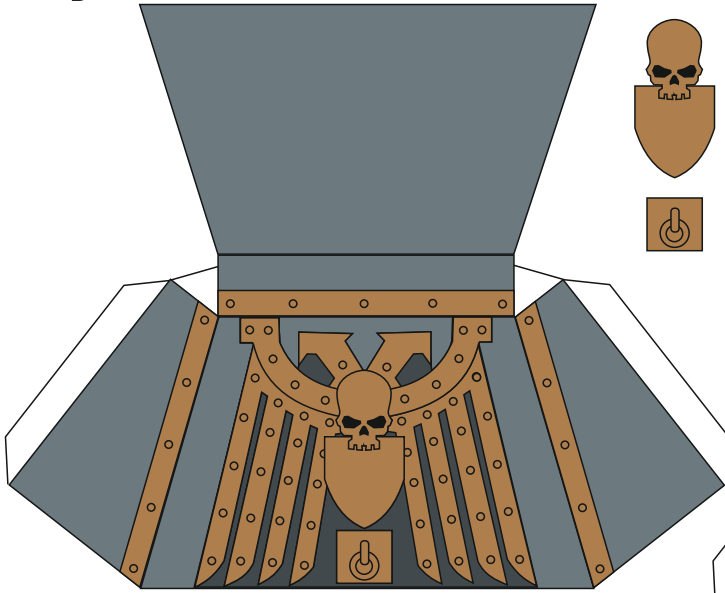

A

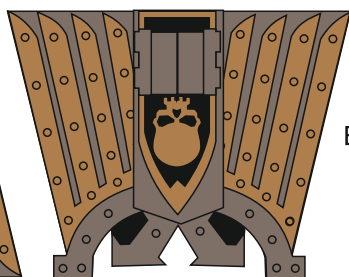
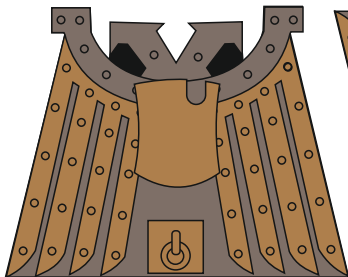
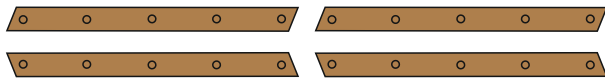
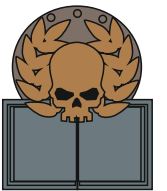
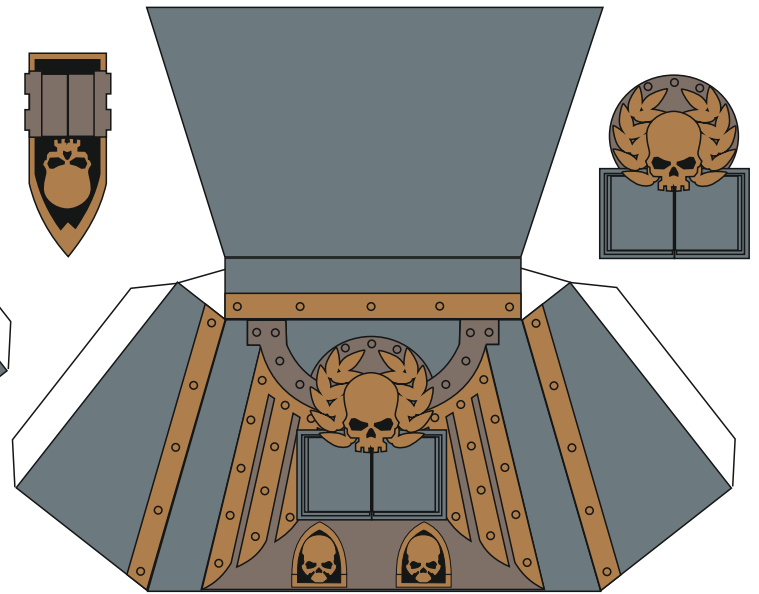
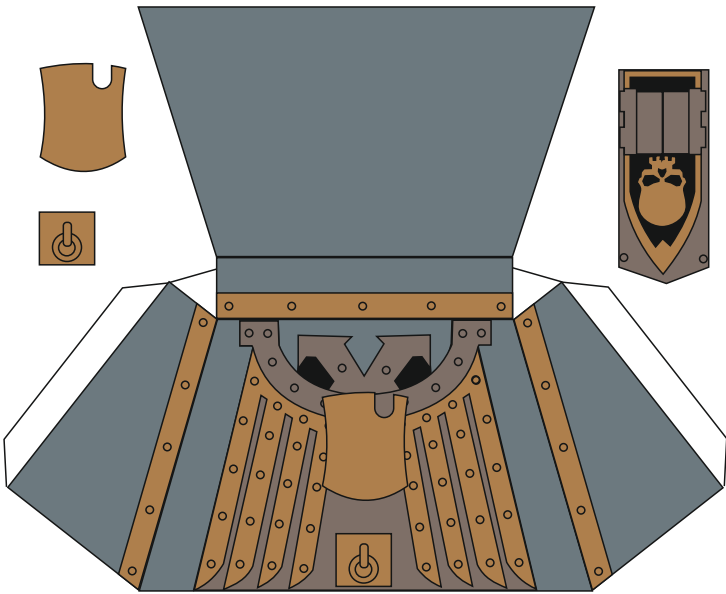
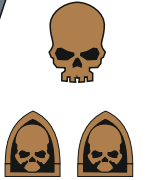

B*

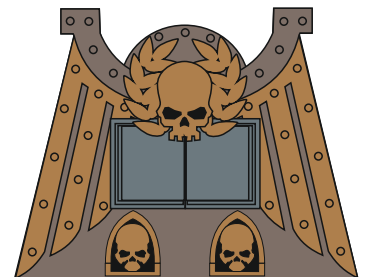
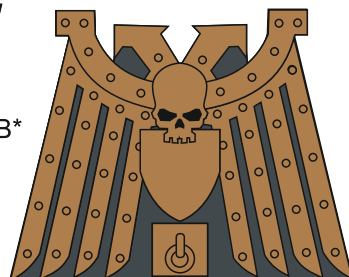

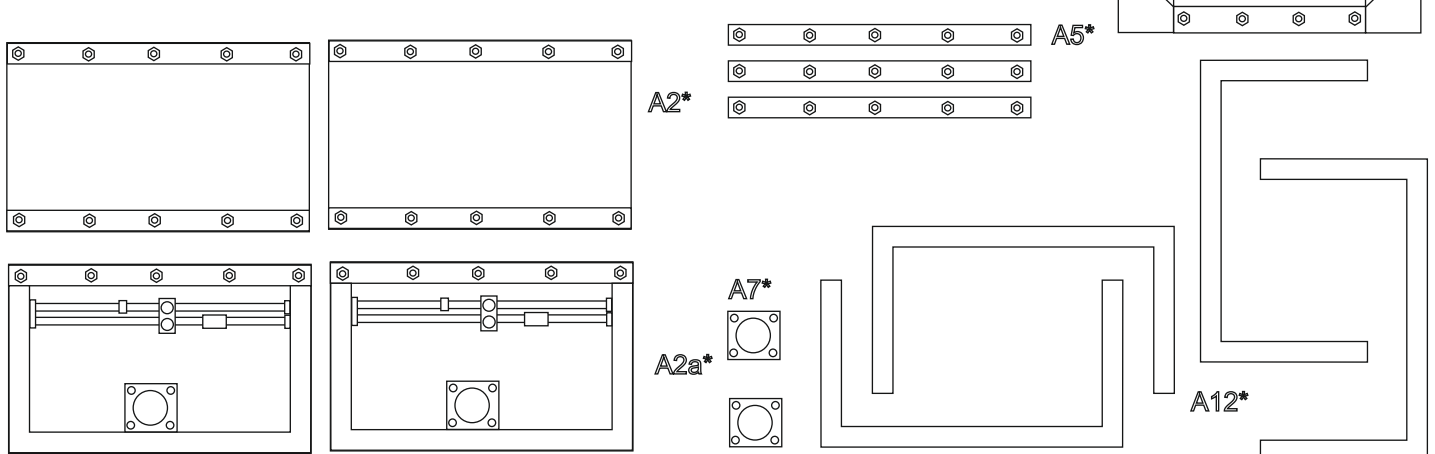
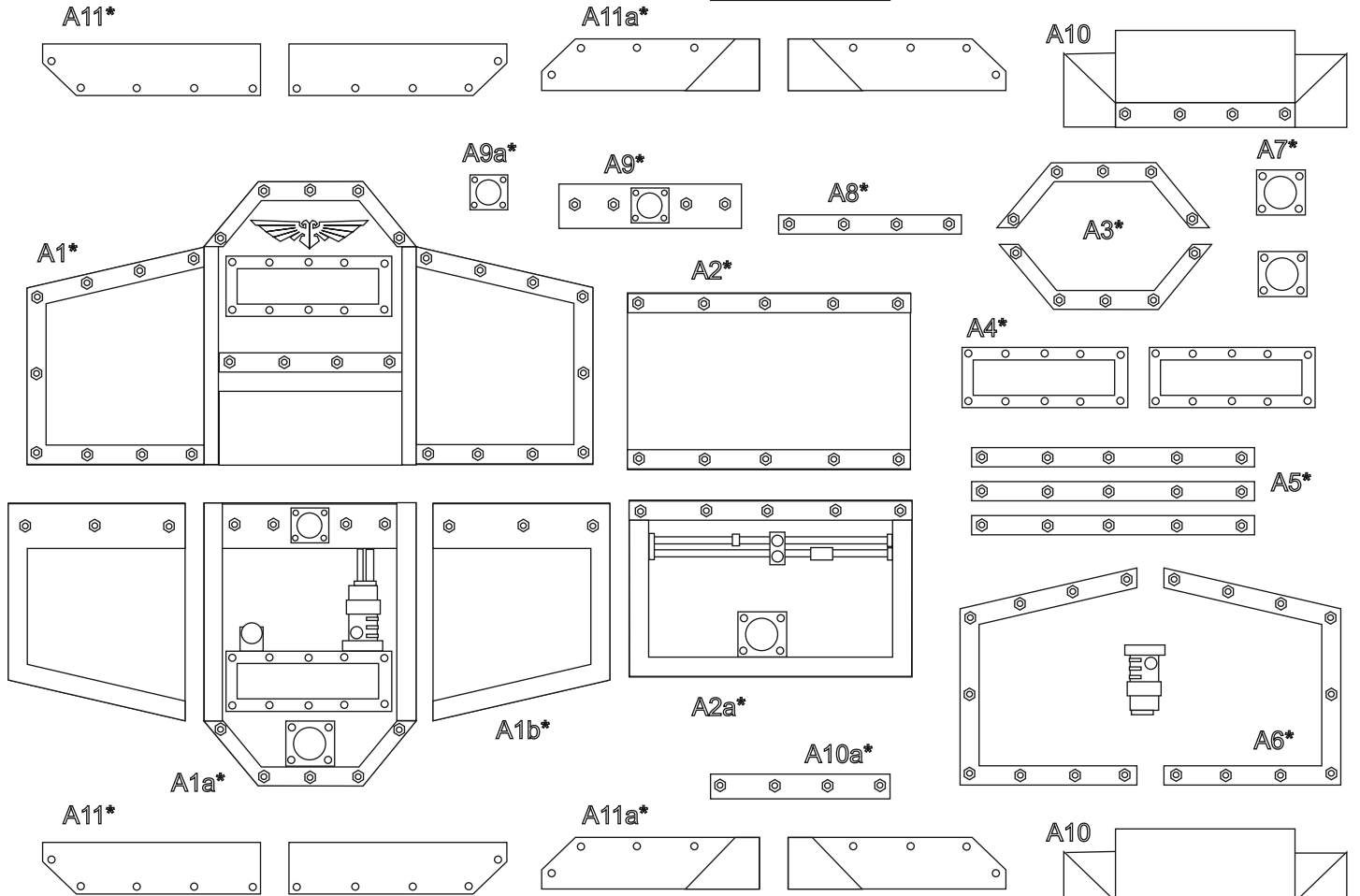
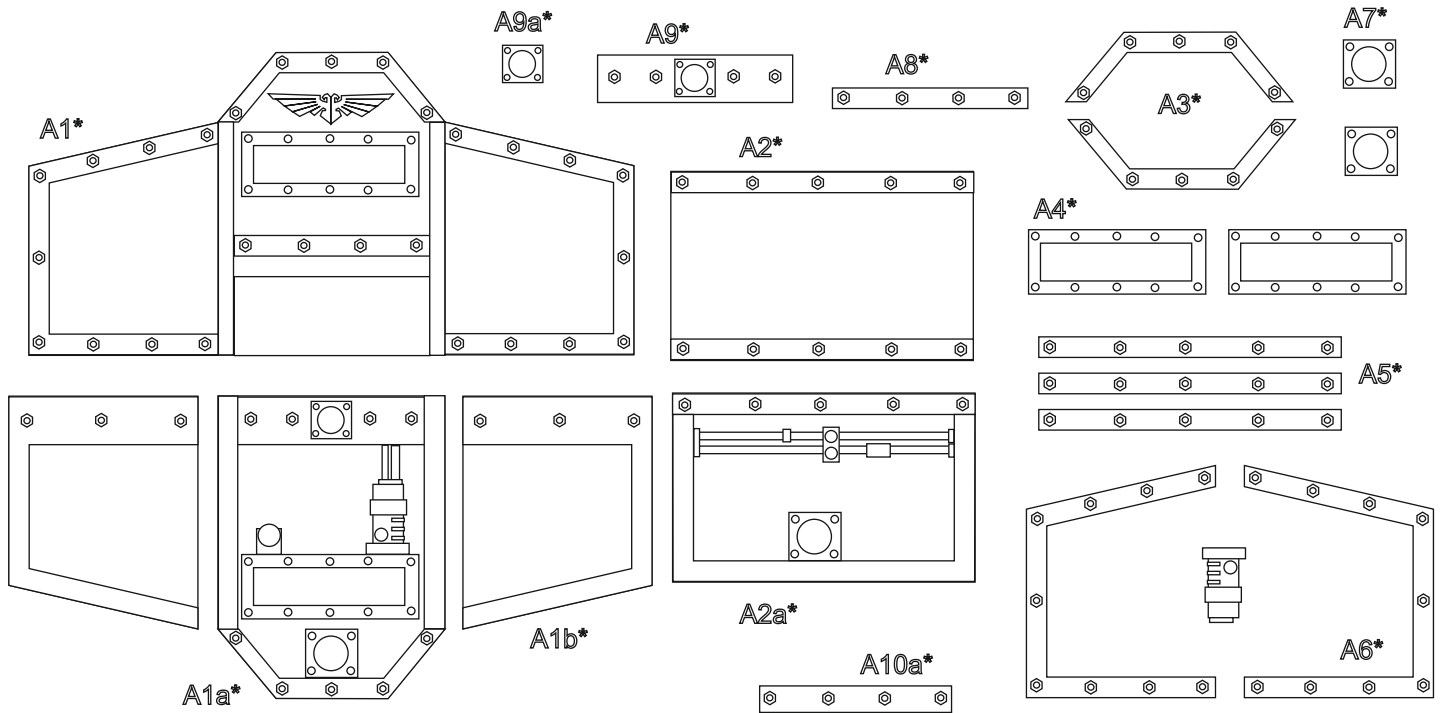

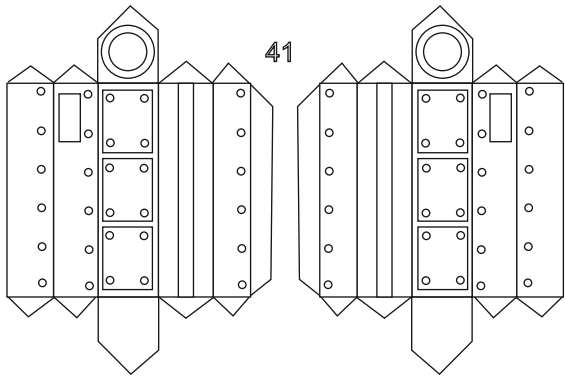

41

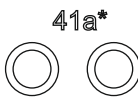

41a*



41b*

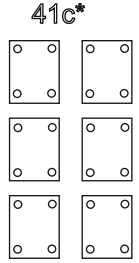

41c*

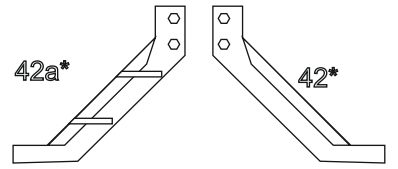

42a*

42*

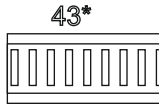

43*

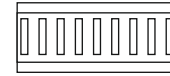

43a

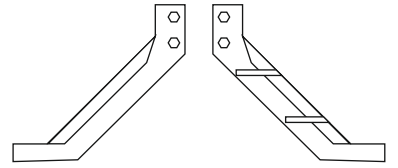
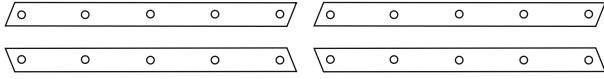

42a*

42*

D*

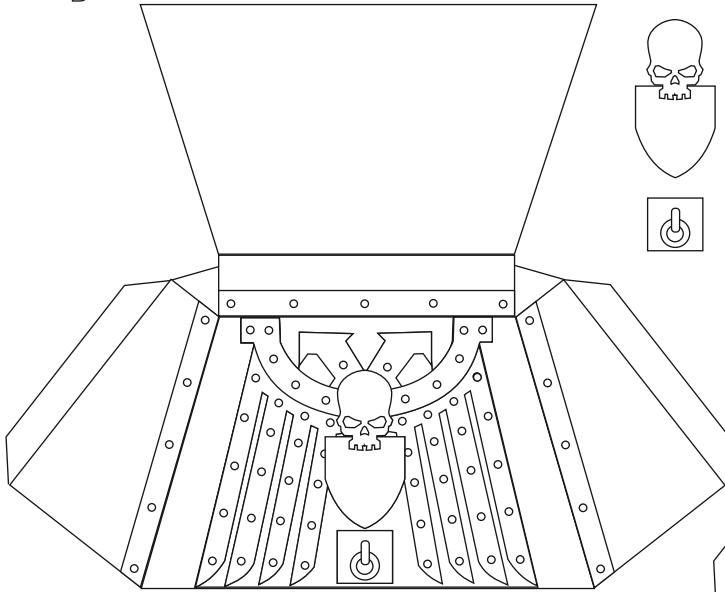

A

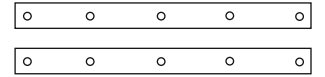
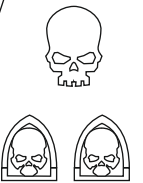
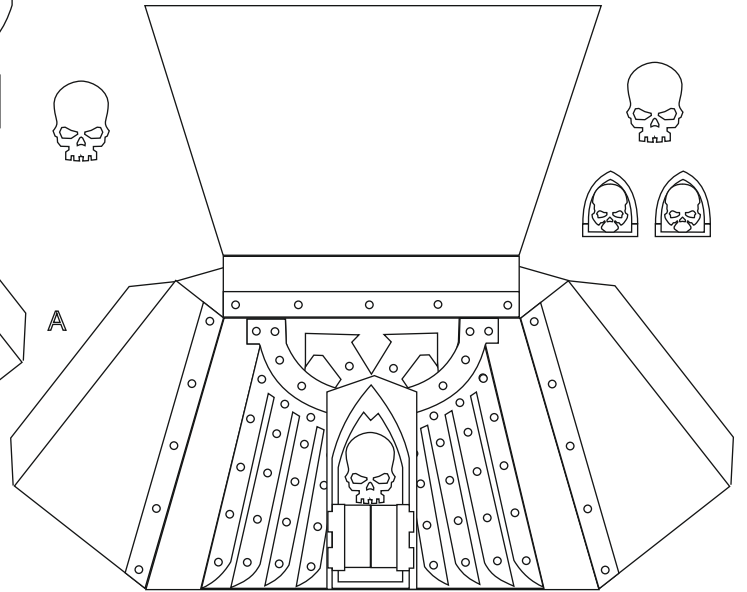

C*

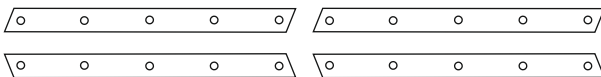
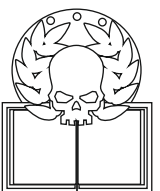
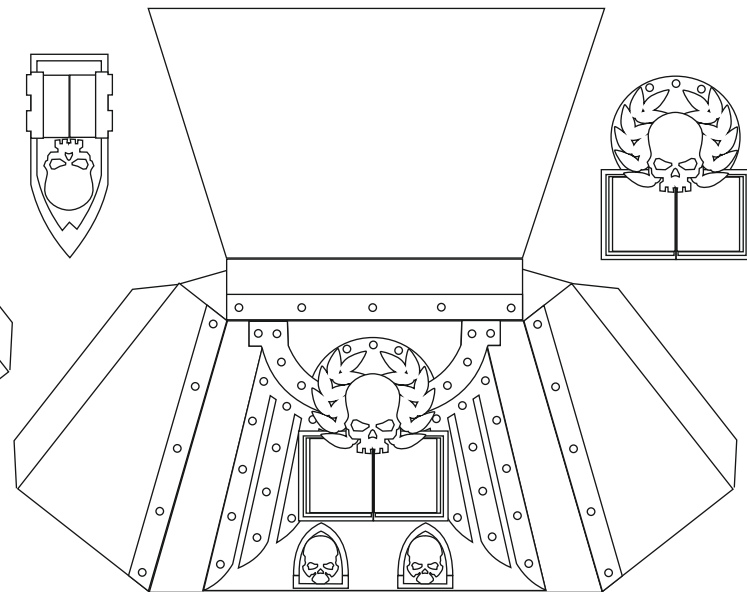
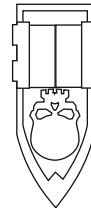
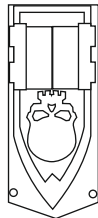
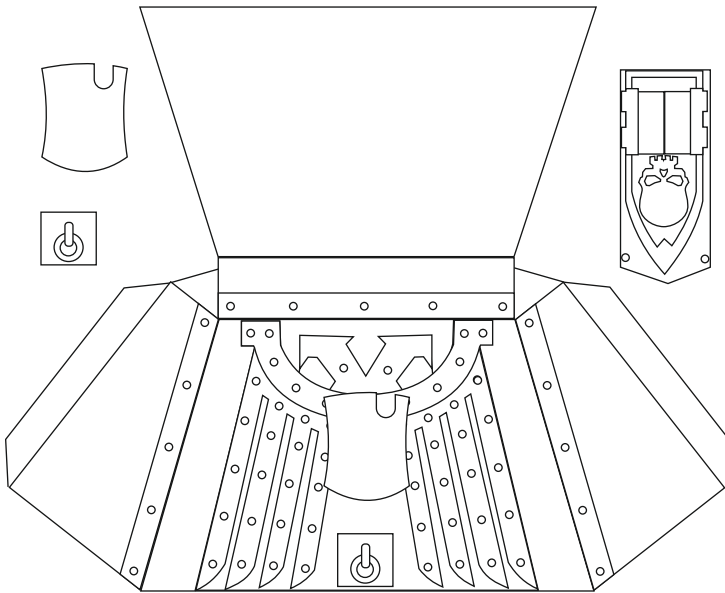

B*

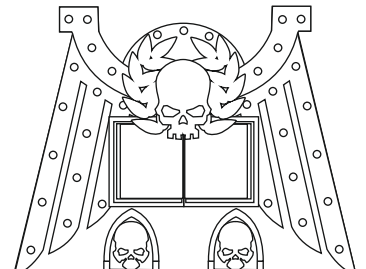
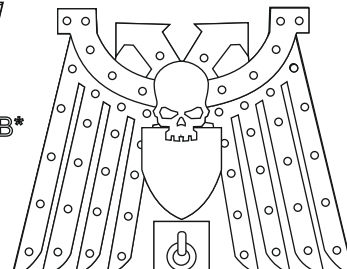
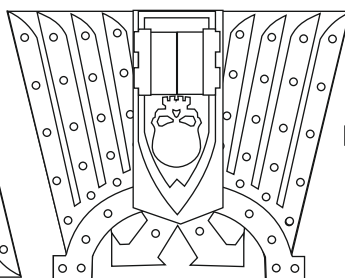
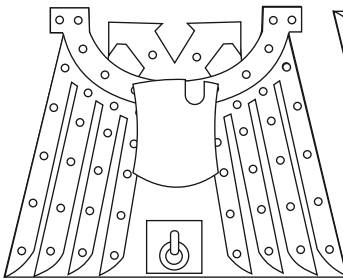

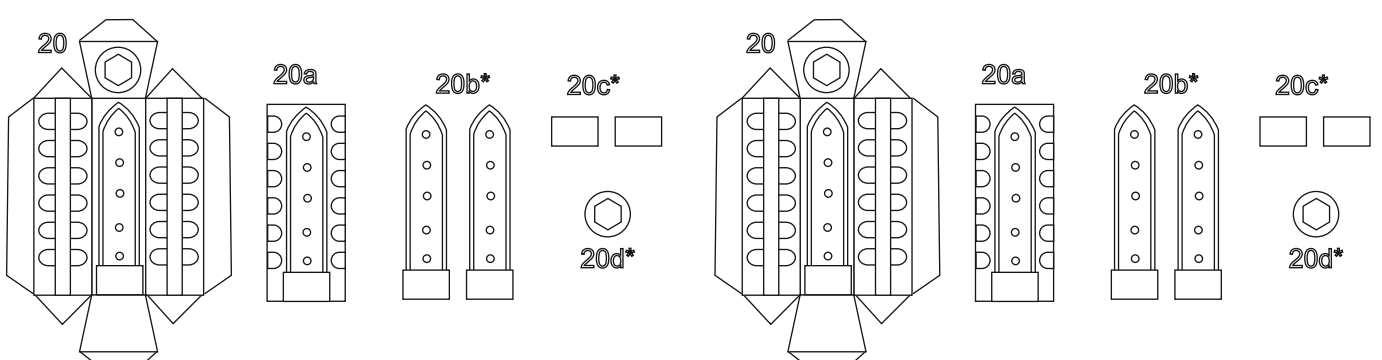
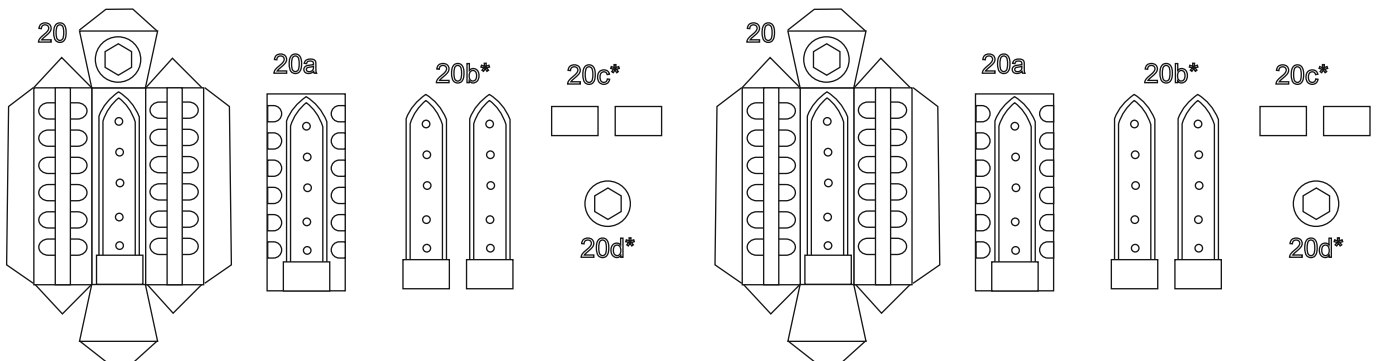
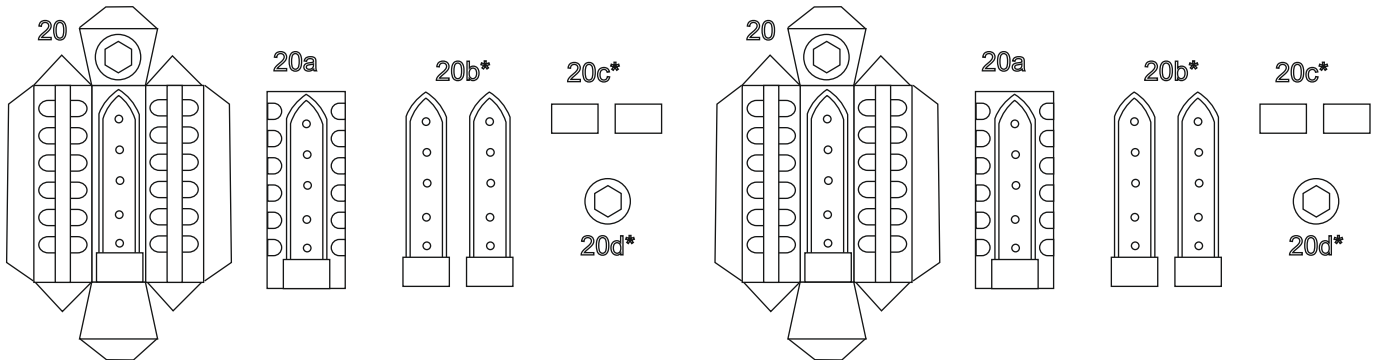
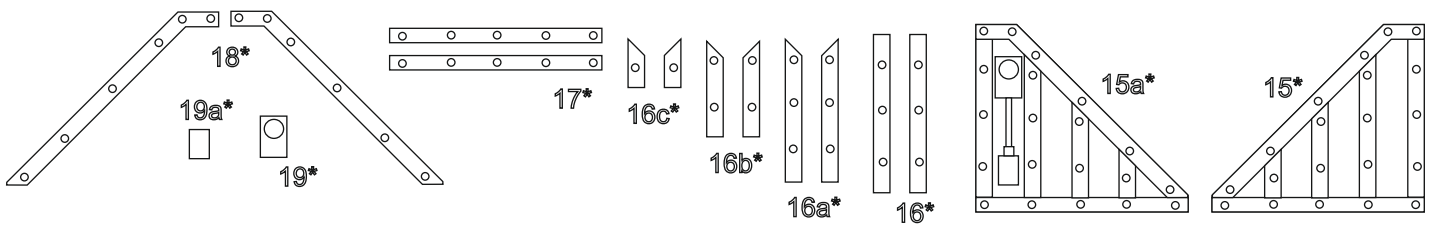
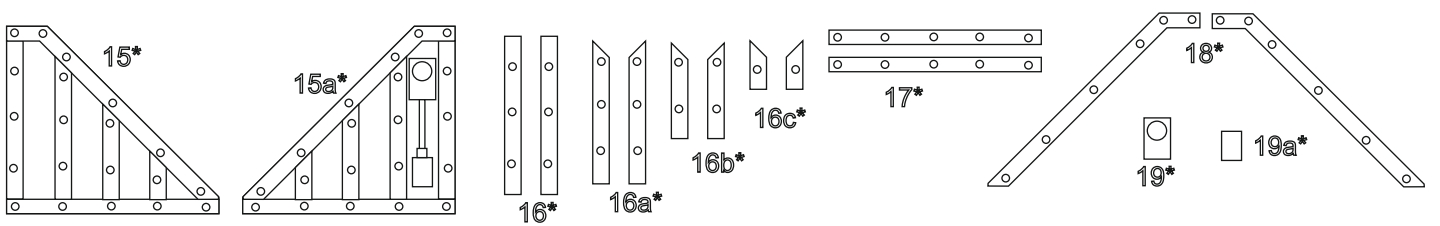
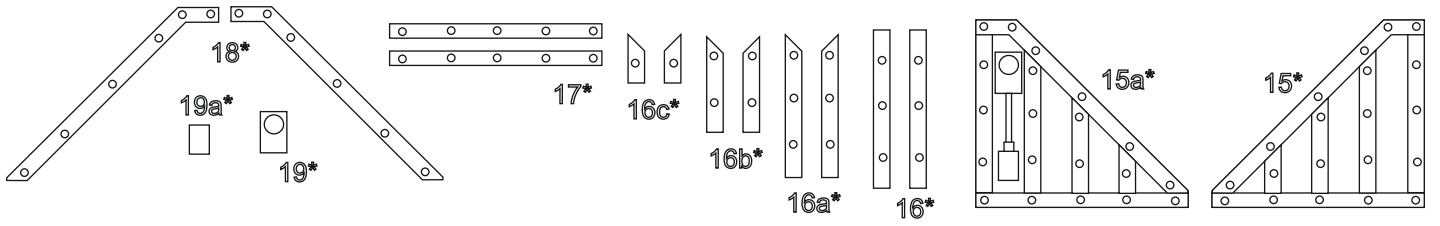
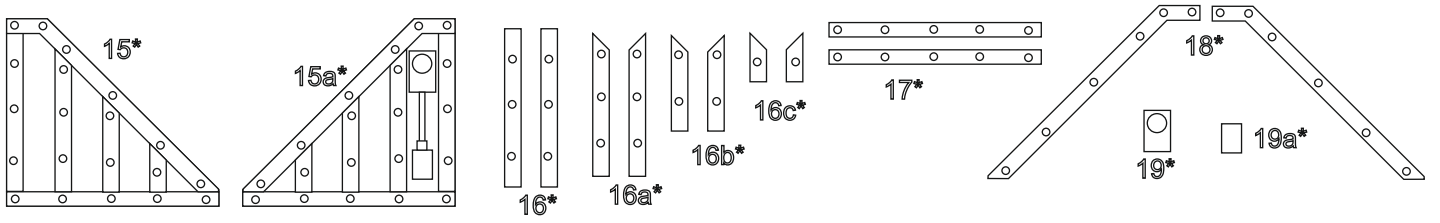

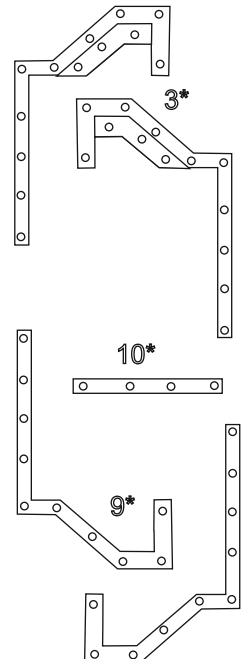
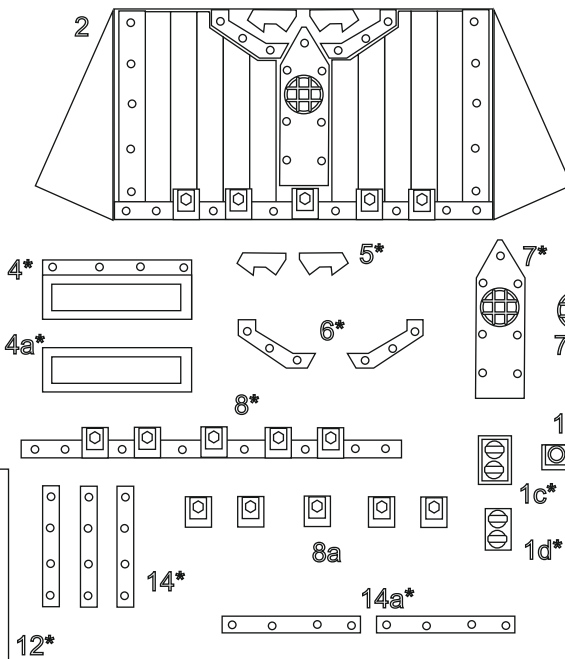
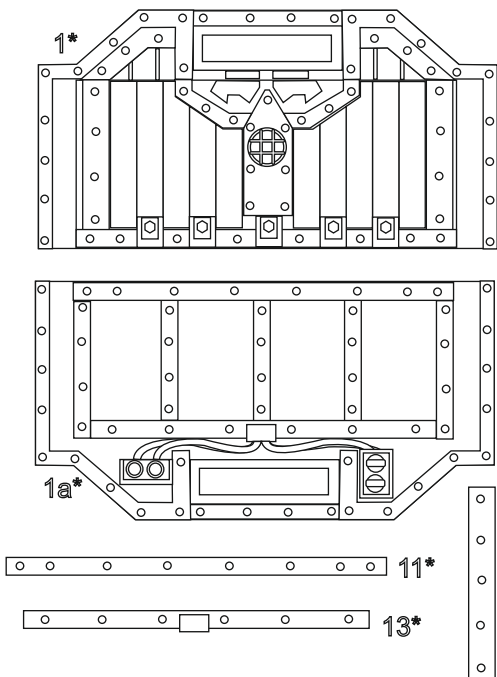
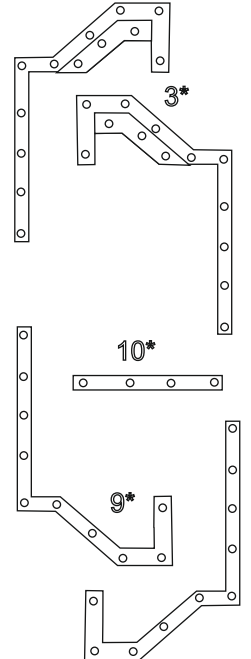
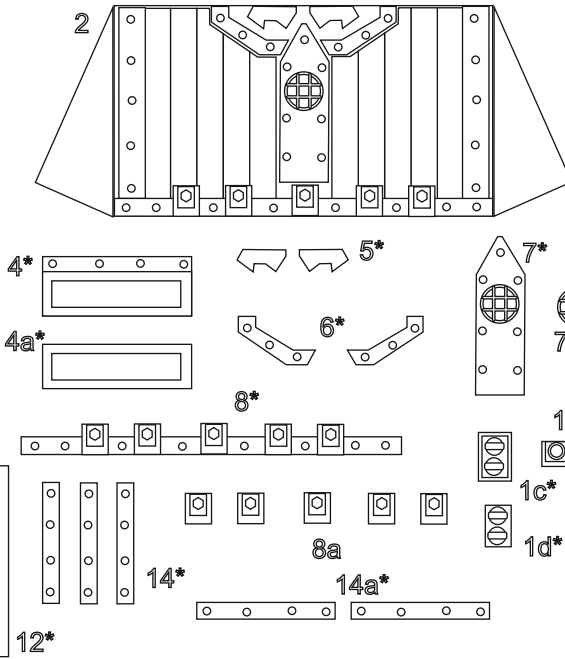
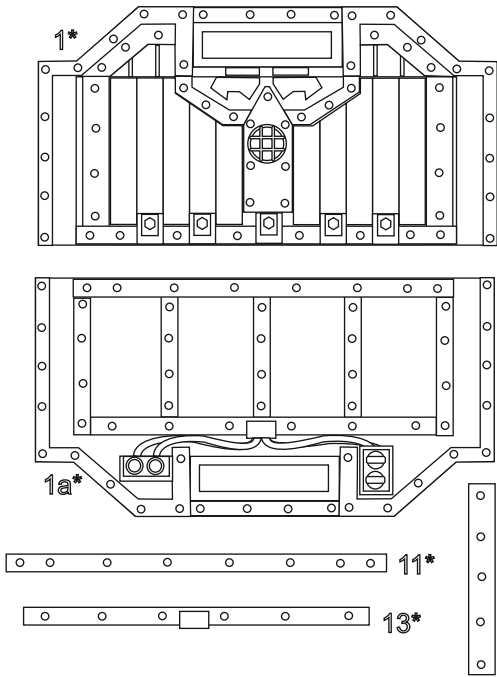
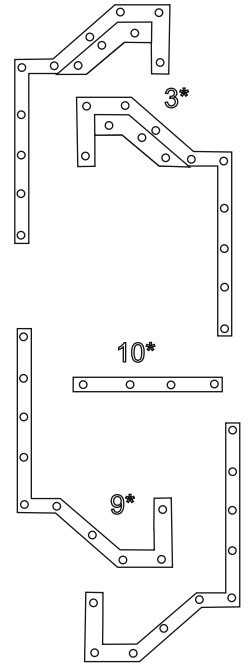
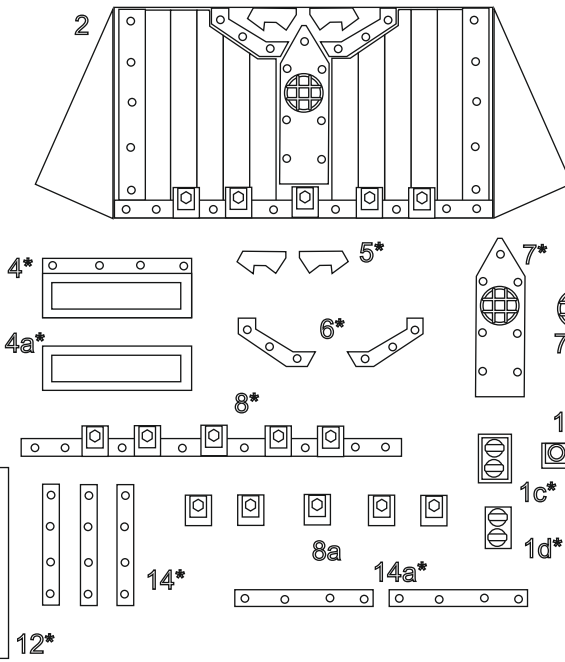
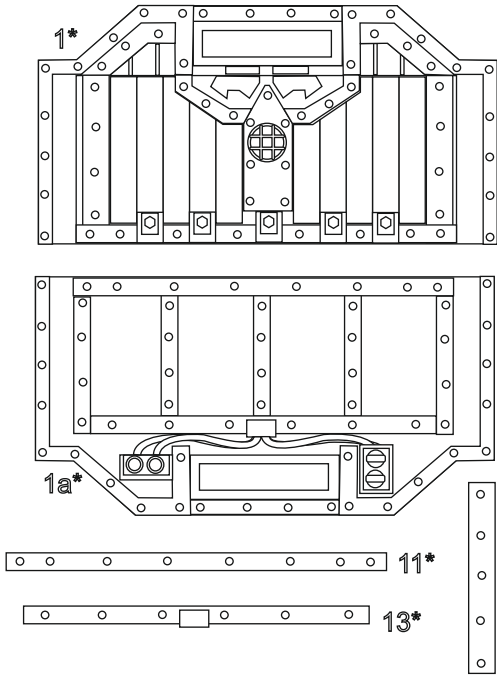

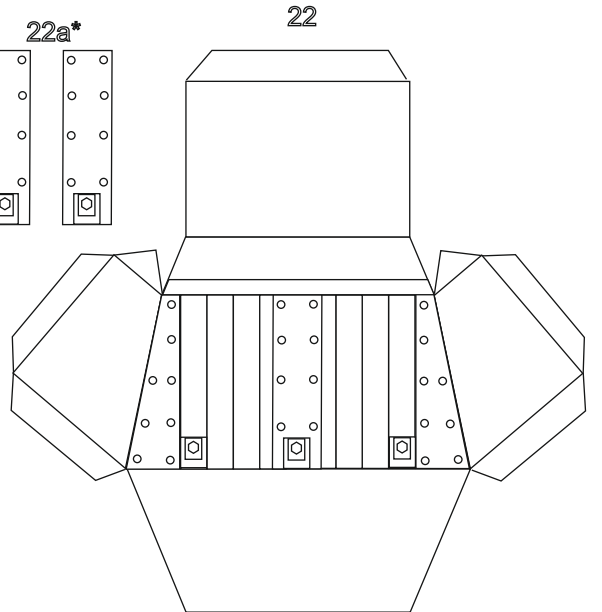
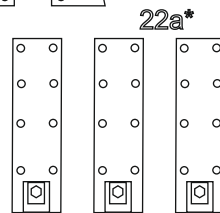
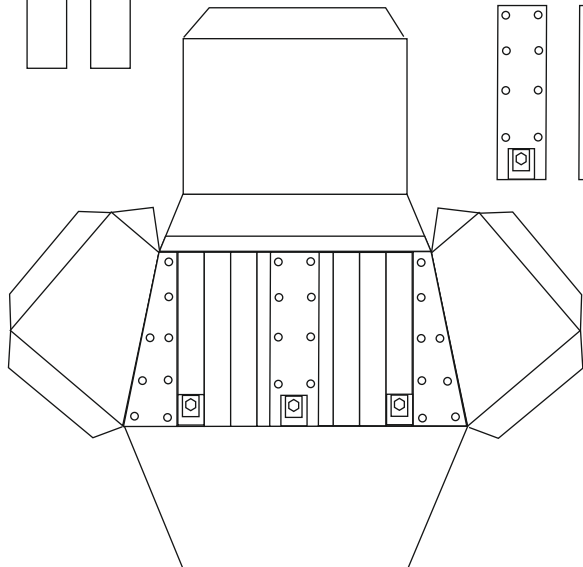
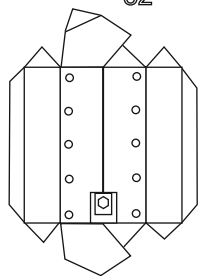
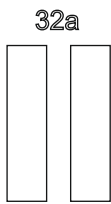
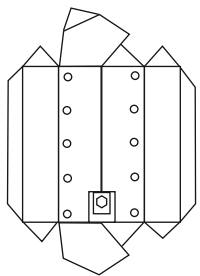
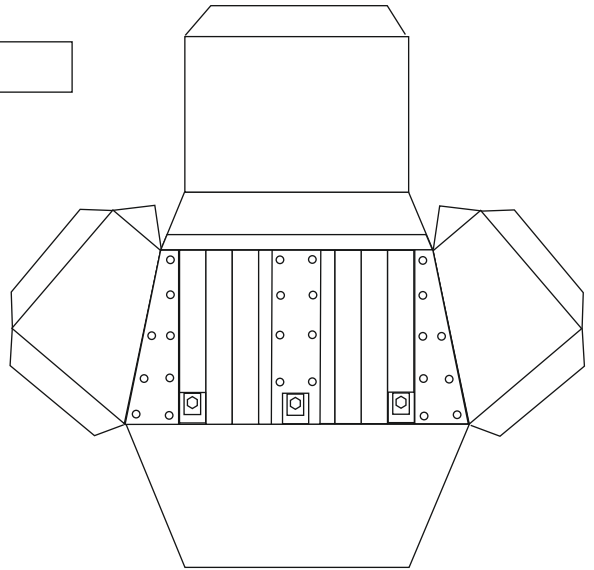
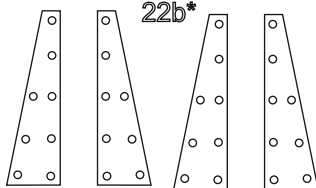
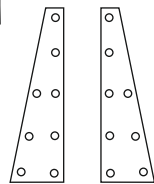
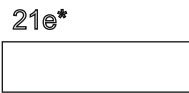
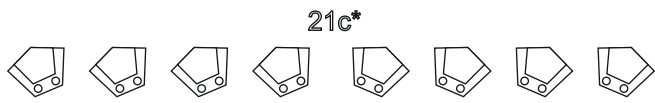
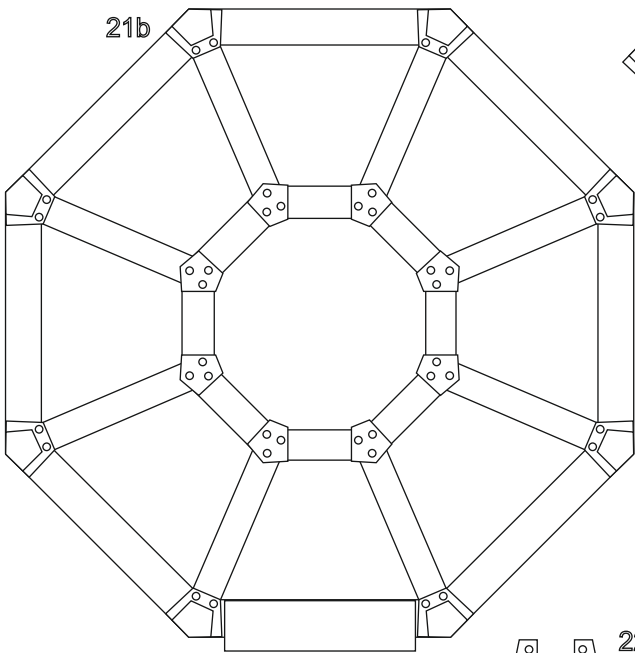
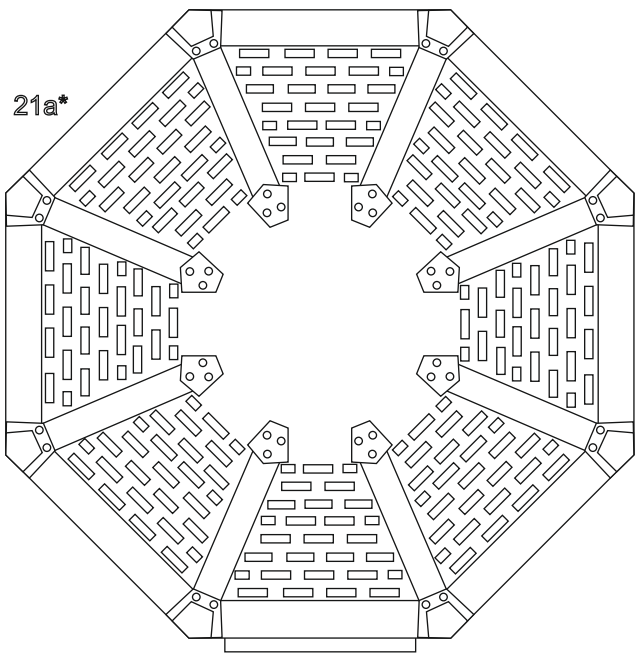
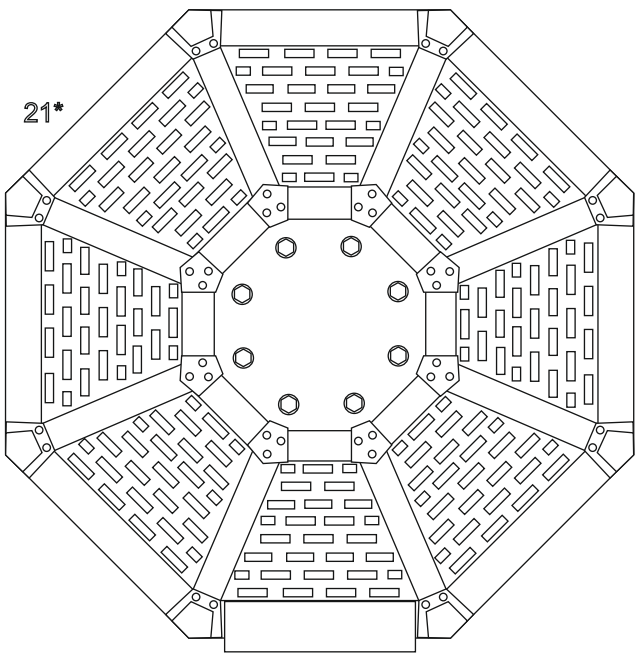

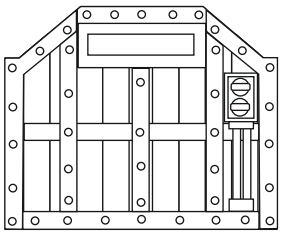

23a*

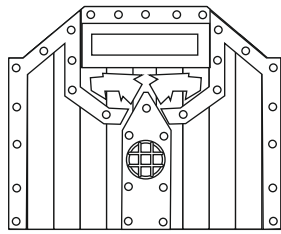

23*

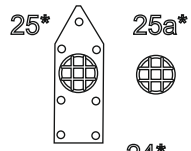

25*



25a*

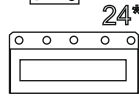

24*

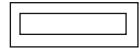

24a*

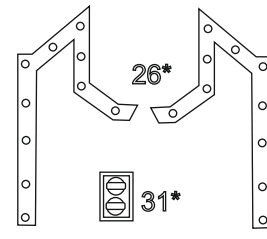

26*

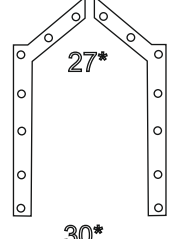

27*



31*

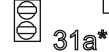

31a*



30*

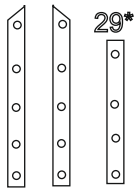

29*

28*

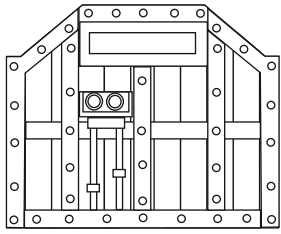

23a*

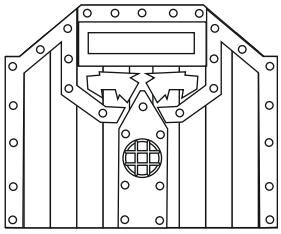

23*

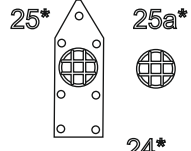

25*



25a*

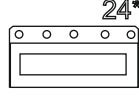

24*

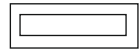

24a*

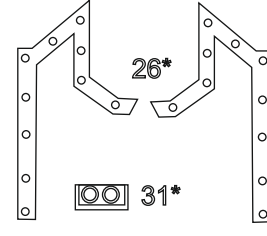

26*

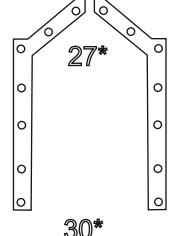

27*



31*

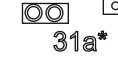

31a*

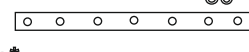

30*

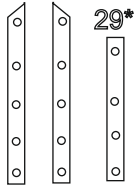

29*

28*

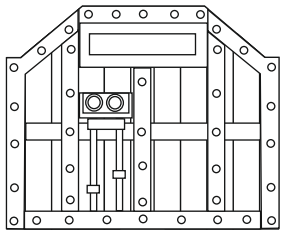

23a*

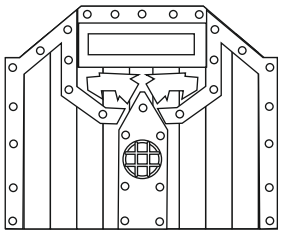

23*

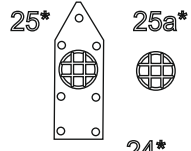

25*



25a*

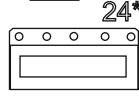

24*

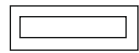

24a*

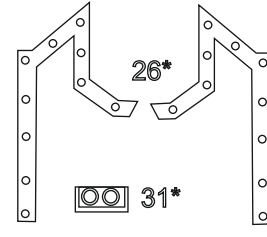

26*

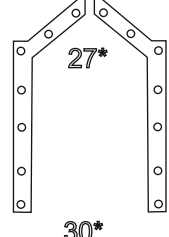

27*



31*

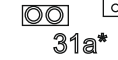

31a*

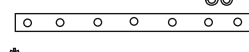

30*

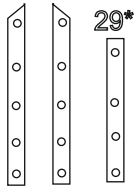

29*

28*

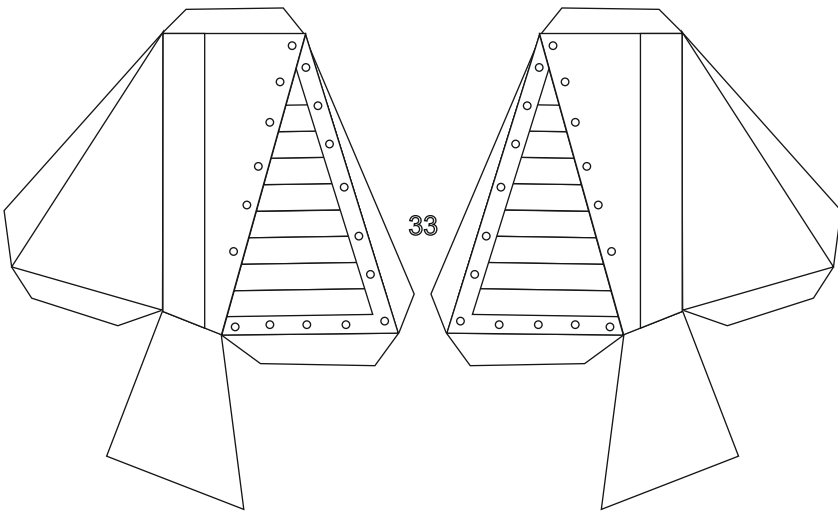

33

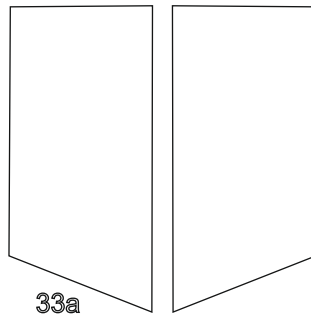

33a

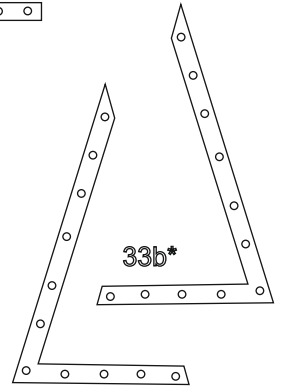

33b*

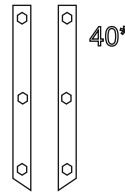

40*

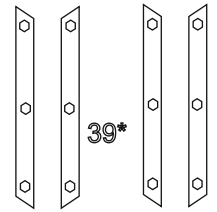

39*

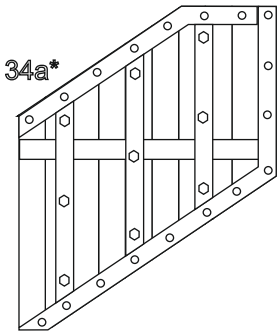

34a*

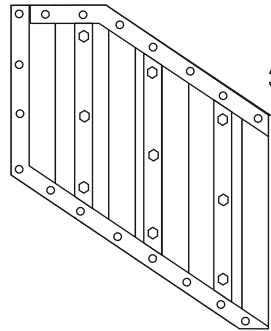

34*

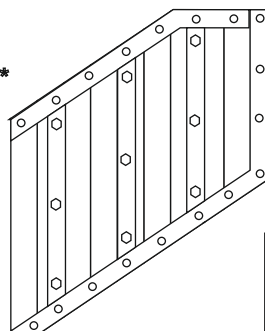

34a*

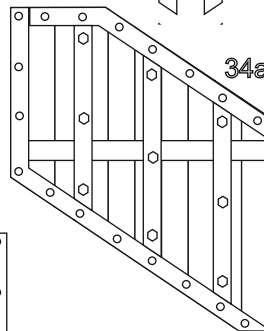

38*

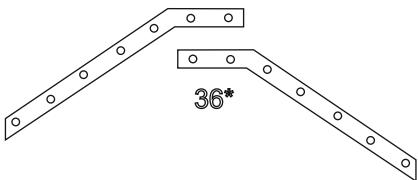

36*

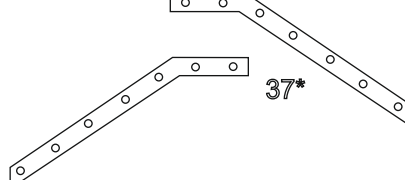

37*

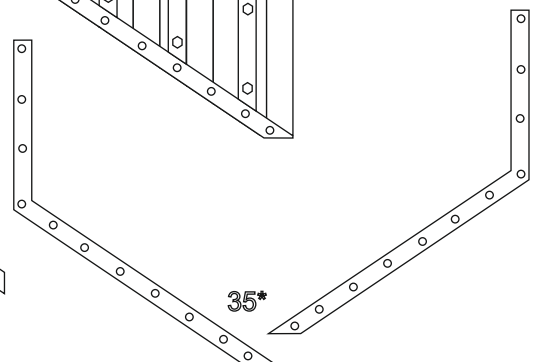

35*